



**Locks for  
metal frames**



<b>Perforza</b>	2-6	<b>Portoncino</b>	2-135
<b>Multiblindo  Motion</b>	2-30	<b>Gates</b>	2-139
<b>Multiblindo Easy</b>	2-36	<b>Shutters and garage doors</b>	2-142
<b>Multiblindo classic</b>	2-44	<b>Chiuditutto</b>	2-146
<b>Electa multipoint</b>	2-71	<b>Match</b>	2-154
<b>Electa</b>	2-79	<b>Stiking plates</b>	2-162
<b>Shutters</b>	2-97		
<b>Locks for metal frames</b>	2-101		
<b>Mortice locks for metal frames</b>	2-108		
<b>2001 - 500 Electric locks</b>	2-125		
<b>Ferroglietto</b>	2-134		

For aluminium frames

For iron frames

Legend





## How to read the marking **UNI EN 12209:05**

**Classification for mechanical locks (lateral locking).**



<b>3</b>	<b>X</b>	<b>8</b>	<b>0</b>	<b>0</b>	<b>G</b>	<b>2</b>	<b>H</b>	<b>A</b>	<b>2</b>	<b>0</b>
Category of use	Durability and load on latchbolt	Door mass and locking force	Suitability for use on fire/smoke resistant doors	People's safety	Corrosion resistance and temperature requirement	Goods' security and drill resistance	Field of door application	Type of key operation and locking	Type of spindle operation	Key identification requirement

### Category of use

There are three grades (example: grade 1: for residential doors, grade 2: for offices doors, grade 3: for doors in public buildings)

### Durability and load on latchbolt

There are twelve grades (example: grade A: 50.000 operations and no load on latchbolt  
grade X: 200.000 operations and 120 N load on latchbolt)

### Door mass and locking force

There are nine grades (example: grade 1: up to 100 kg door mass with 50 N maximum locking force, grade 9: over 200 kg door mass with 15 N maximum locking force)

### Suitability for use on fire/smoke resistant doors

There are two grades (example: grade 0: non suitable for use on fire/smoke resistant door, grade 1: suitable for use on fire/smoke resistant door)

### People's safety

There is only one grade: grade 0: no safety requirement

### Corrosion resistance and temperature requirement

There are eight grades (example: grade 0: no corrosion resistance and temperature requirement, grade G: very high corrosion resistance and temperature requirement from -20°C up to +80°C)

### Goods' security and drill resistance

There are seven grades (example: grade 1: minimum security and no drill resistance, grade 7: very high security and drill resistance)

### Field of door application

There are fifteen grades (example: grade A: mortice lock for sliding or hinged door, grade T: rim lock for sliding or hinged door, front plate not supported)

### Type of key operation and locking

There are nine grades (example: grade A: cylinder lock or latch; manually locking,  
grade H: lock without key operation and automatically locking)

### Type of spindle operation

There are five grades (example: grade 0: lock or latch without follower, grade 4: lock or latch for heavy duty unsprung lever handle operation specified by the manufacturer)

### Key identification requirement

There are nine grades (example: grade 0: no requirements, grade H: minimum eight detaining elements, extended number of effective differs)

**For further information please refer to UNI EN 12209:05 standard**



## How to read the marking **prEN 15685**

**Classification for mechanical locks  
(multipoint locking).**



<b>3</b>	<b>X</b>	<b>8</b>	<b>A</b>	<b>0</b>	<b>G</b>	<b>7</b>	<b>3</b>	<b>0</b>
<b>Category of use</b>	<b>Durability and load on latchbolt</b>	<b>Door mass and locking force</b>	<b>Suitability for use on fire/smoke resistant doors</b>	<b>Key identification requirement</b>	<b>Corrosion resistance and temperature requirement</b>	<b>Security for locking points</b>	<b>Security for anti-separation points</b>	<b>Clenching points</b>

### **Category of use**

There are three grades (example: grade 1: for residential doors, grade 2: for offices doors, grade 3: for doors in public building)

### **Durability and load on latchbolt**

There are ten grades (example: grade A: 50.000 operations and no load on latchbolt for locks without latchbolt, grade Z: 500.000 operations and 120 N load on latchbolt)

### **Door mass and locking force**

There are ten grades (example: grade 1: up to 100 kg door mass and 50 N maximum locking force, grade 9: over 200 kg door mass and 15 N maximum locking force)

### **Suitability for use on fire/smoke resistant doors**

There are three grades (example: grade 0: non suitable for use on fire/smoke resistant door, grade B: suitable for use on fire/smoke resistant door)

### **Key identification requirement**

There are nine grades (example: grade 0: not applicable, grade H: minimum eight detaining elements, extended number of effective duffers)

### **Corrosion resistance and temperature requirement**

There are eight grades (example: grade 0: no corrosion resistance and no temperature requirement, grade G: very high corrosion resistance and temperature requirement from -25°C up to +70°C)

### **Security for locking points**

There are six grades (example: grade 0: no security requirements, grade 7: very high security with drill resistance)

### **Security for anti-separation points**

There are eight grades (example: grade 0: no declared anti-separation points, grade 7: very high performance with drill resistance)

### **Clenching point**

There are five grades (example: grade 0: no clenching force requirements, grade 4: clenching force = 120 N)

**For further information please refer to prEN 15685 standard**



**Perforza**  
Multipoint lock



## Perforza

**PERFORMA** by Iseo has been conceived and developed to meet the requirements of the European market by adopting two different centre distances: 85 and 92 mm. It can be operated by a European-profile cylinder with straight or 45° projecting cam. The top and bottom lock housings incorporate low friction chamfered sliding deadbolts providing a perfect alignment into the keeps. The unique locking action of these chamfered bolts when combined with the latest generation of profiles helps maintain weather seal compression for better thermal insulation and energy saving.



### It has been designed and tested

according to the European standards EN 12209:05 and prEN 15685:09. It resists lateral forcing with a thrust of over 1,000 kg and a front load of over 600 kg. The corrosion resistance is more than 240 hours in a saline environment. Endurance: tested to over 200,000 opening and closing cycles under a 120N load.

Example of certification: multipoint lock Performa models 7232 – 7235

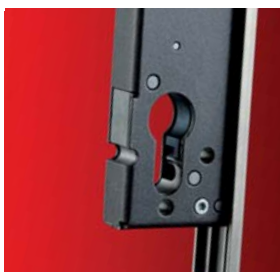

### It's compatible

The lockcase has a width of 15 mm and, therefore, suits any type of applications for different frames materials.



### It's sealed

The lockcase is closed on all sides: this stops profile machining chips from entering the mechanism. The lock is equipped with a wheel-cam stopping device in case the cylinder is not present into the housing of lock.



### Easy locking

The gear box allows for a smoother and easier operation whilst turning the key during opening and closing.

### It's solid

Version with hardened deadbolts available on demand, providing greater resistance against cutting and drilling.



### It's well equipped

PERFORMA is well equipped with accessories to modify the lock: with a latch, a roller or a blanking cap for DEADBOLT only action. Such a versatile lock makes for a streamlined stockholding.

# Locks for metal frames



## Perforza 85 mm centre distance

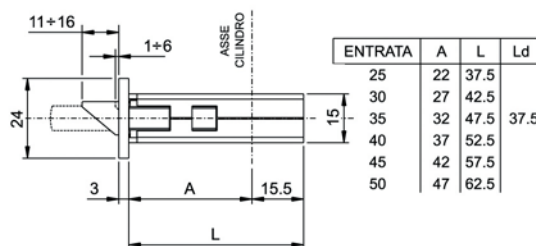
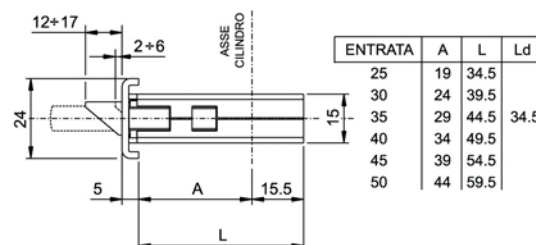
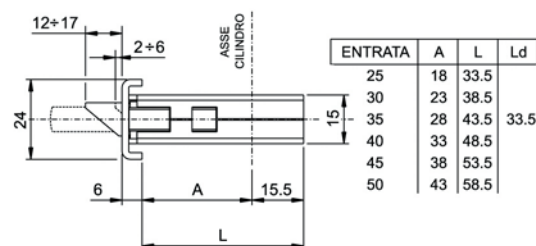
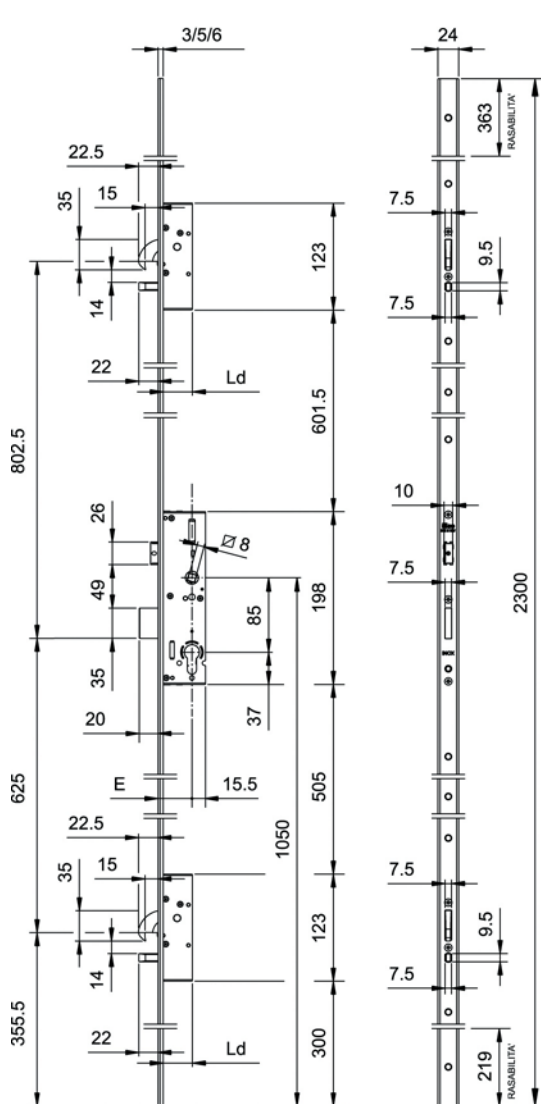
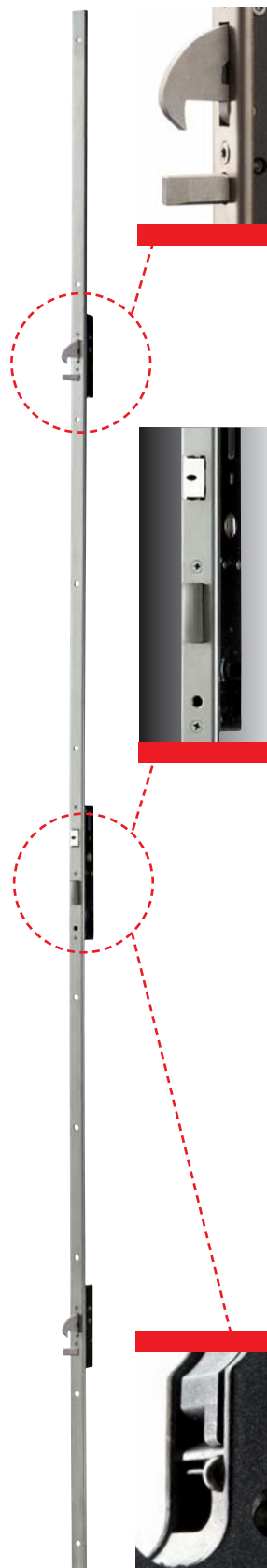

MULTIPOINT mortice lock for metal frames, 3-point locking,  
**ROTATING HOOK DEVIATORS AND SLIDING DEADBOLT LOCK**

Central lock, centre distance mm **85**, profile cylinder.

Throw mm 20, **reversible latchbolt**. The latchbolt can be replaced with roller or cap, mm 8 handle follower.

Closed case for lock and deviators.

2 nylon end blocks for U-version. Fixing screws. Instruction sheet.

The lock is equipped with a wheel-cam stopping device in case the cylinder is not assembled into the housing of lock.

**STAINLESS STEEL front plate.**

**Accessories to be ordered separately:**

Roller for central lock 040940

Cap for DEADBOLT only versions 040950

Striking plates

Electric strikers



# Locks for metal frames



Code

Status  
Single  
package

Min. ord.

## Perforza 85 mm centre distance

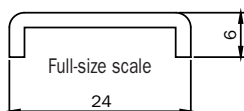

U-front plate mm <b>2300 x 24 x 6</b> in stainless steel. 85 mm centre distance. Backset mm 25 * <b>7255512528</b>	D	1	-	1
U-front plate mm <b>2300 x 24 x 6</b> in stainless steel. 85 mm centre distance. Backset mm 30 * <b>7255513028</b>	D	1	-	1
U-front plate mm <b>2300 x 24 x 6</b> in stainless steel. 85 mm centre distance. Backset mm 35 * <b>7255513528</b>	D	1	-	1
U-front plate mm <b>2300 x 24 x 6</b> in stainless steel. 85 mm centre distance. Backset mm 40 * <b>7255514028</b>	D	1	-	1
U-front plate mm <b>2300 x 24 x 6</b> in stainless steel. 85 mm centre distance. Backset mm 45 * <b>7255514528</b>	D	1	-	1
U-front plate mm <b>2300 x 24 x 6</b> in stainless steel. 85 mm centre distance. Backset mm 50 * <b>7255515028</b>	D	1	-	1

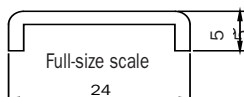

U-front plate mm <b>2300 x 24 x 5</b> in stainless steel. 85 mm centre distance. Backset mm 25 * <b>7255532528</b>	D	1	-	1
U-front plate mm <b>2300 x 24 x 5</b> in stainless steel. 85 mm centre distance. Backset mm 30 * <b>7255533028</b>	D	1	-	1
U-front plate mm <b>2300 x 24 x 5</b> in stainless steel. 85 mm centre distance. Backset mm 35 * <b>7255533528</b>	D	1	-	1
U-front plate mm <b>2300 x 24 x 5</b> in stainless steel. 85 mm centre distance. Backset mm 40 * <b>7255534028</b>	D	1	-	1
U-front plate mm <b>2300 x 24 x 5</b> in stainless steel. 85 mm centre distance. Backset mm 45 * <b>7255534528</b>	D	1	-	1
U-front plate mm <b>2300 x 24 x 5</b> in stainless steel. 85 mm centre distance. Backset mm 50 * <b>7255535028</b>	D	1	-	1

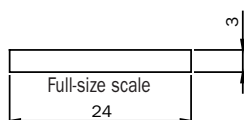

Flat front plate mm <b>2300 x 24 x 3</b> in stainless steel. 85 mm centre distance. Backset mm 25 * <b>7255012528</b>	D	1	-	1
Flat front plate mm <b>2300 x 24 x 3</b> in stainless steel. 85 mm centre distance. Backset mm 30 * <b>7255013028</b>	D	1	-	1
Flat front plate mm <b>2300 x 24 x 3</b> in stainless steel. 85 mm centre distance. Backset mm 35 * <b>7255013528</b>	D	1	-	1
Flat front plate mm <b>2300 x 24 x 3</b> in stainless steel. 85 mm centre distance. Backset mm 40 * <b>7255014028</b>	D	1	-	1
Flat front plate mm <b>2300 x 24 x 3</b> in stainless steel. 85 mm centre distance. Backset mm 45 * <b>7255014528</b>	D	1	-	1
Flat front plate mm <b>2300 x 24 x 3</b> in stainless steel. 85 mm centre distance. Backset mm 50 * <b>7255015028</b>	D	1	-	1

\* Available starting from the second half of 2010



**Perforza 85 mm centre distance**

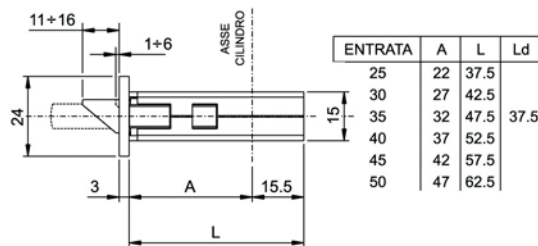
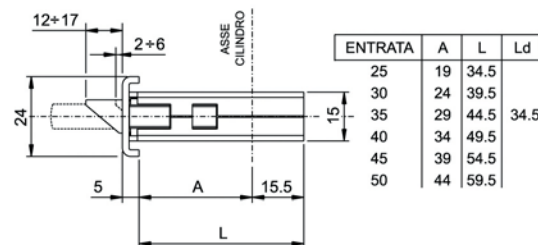
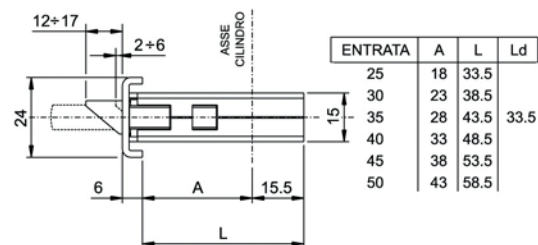
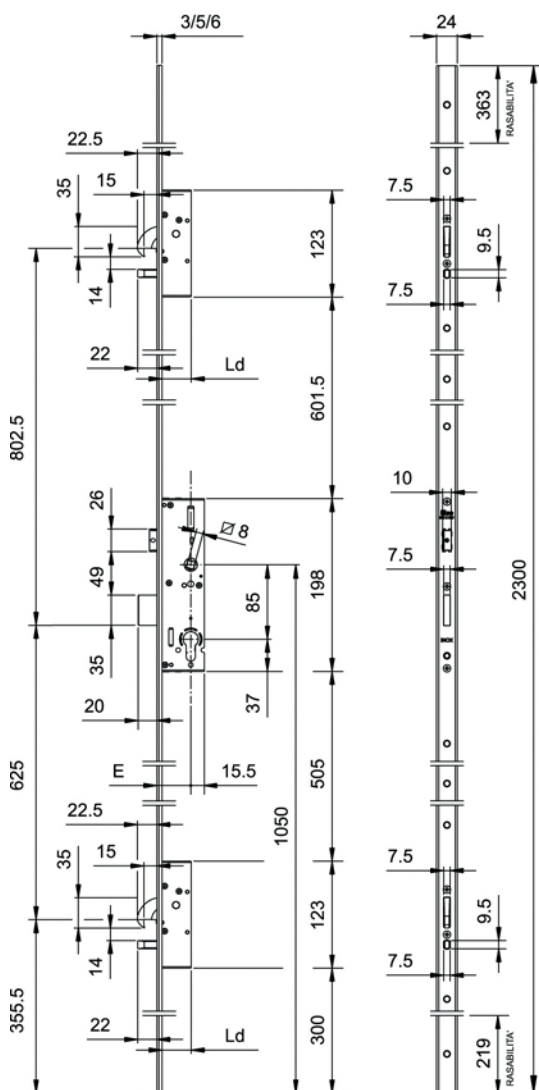
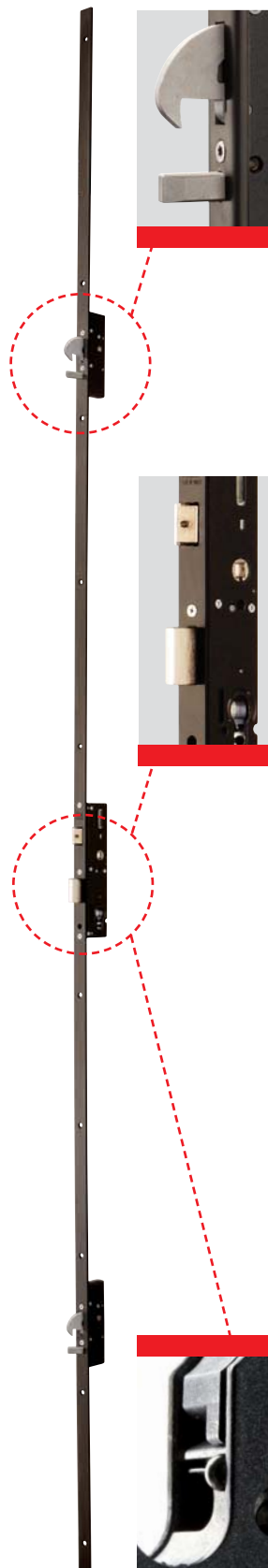

MULTIPOINT mortice lock for metal frames, 3-point locking,  
**ROTATING HOOK DEVIATORS AND SLIDING DEADBOLT LOCK**

Central lock, centre distance mm **85**, European profile cylinder.

Throw mm 20, **reversible latchbolt**. The latchbolt can be replaced with roller or cap, mm 8 HANDLE FOLLOWER.

Closed case for lock and deviators.

2 nylon end blocks for U-version. Fixing screws. Instruction sheet.

The lock is equipped with a wheel-cam stopping device in case the cylinder is not assembled into the housing of lock.

**Black painted steel front plate.**

**Accessories to be ordered separately:**

Roller for CENTRAL LOCK 040940

Cap for DEADBOLT only versions 040950

Striking plates

Electric strikers



Code  
Status  
Single  
package  
Multiple  
package  
Min. ord.

**Perforza 85 mm centre distance**

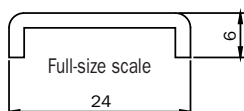

U-front plate mm <b>2300 x 24 x 6</b> in black painted steel. 85 mm centre distance. Backset mm 25 * <b>7255512508</b> D	1	-	1
U-front plate mm <b>2300 x 24 x 6</b> in black painted steel. 85 mm centre distance. Backset mm 30 * <b>7255513008</b> D	1	-	1
U-front plate mm <b>2300 x 24 x 6</b> in black painted steel. 85 mm centre distance. Backset mm 35 * <b>7255513508</b> D	1	-	1
U-front plate mm <b>2300 x 24 x 6</b> in black painted steel. 85 mm centre distance. Backset mm 40 * <b>7255514008</b> D	1	-	1
U-front plate mm <b>2300 x 24 x 6</b> in black painted steel. 85 mm centre distance. Backset mm 45 * <b>7255514508</b> D	1	-	1
U-front plate mm <b>2300 x 24 x 6</b> in black painted steel. 85 mm centre distance. Backset mm 50 * <b>7255515008</b> D	1	-	1

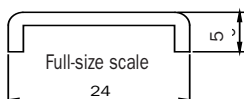

U-front plate mm <b>2300 x 24 x 5</b> in black painted steel. 85 mm centre distance. Backset mm 25 * <b>7255532508</b> D	1	-	1
U-front plate mm <b>2300 x 24 x 5</b> in black painted steel. 85 mm centre distance. Backset mm 30 * <b>7255533008</b> D	1	-	1
U-front plate mm <b>2300 x 24 x 5</b> in black painted steel. 85 mm centre distance. Backset mm 35 * <b>7255533508</b> D	1	-	1
U-front plate mm <b>2300 x 24 x 5</b> in black painted steel. 85 mm centre distance. Backset mm 40 * <b>7255534008</b> D	1	-	1
U-front plate mm <b>2300 x 24 x 5</b> in black painted steel. 85 mm centre distance. Backset mm 45 * <b>7255534508</b> D	1	-	1
U-front plate mm <b>2300 x 24 x 5</b> in black painted steel. 85 mm centre distance. Backset mm 50 * <b>7255535008</b> D	1	-	1

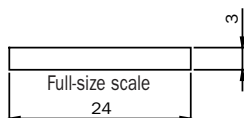

Flat front plate mm <b>2300 x 24 x 3</b> in black painted steel. 85 mm centre distance. Backset mm 25 * <b>7255012508</b> D	1	-	1
Flat front plate mm <b>2300 x 24 x 3</b> in black painted steel. 85 mm centre distance. Backset mm 30 * <b>7255013008</b> D	1	-	1
Flat front plate mm <b>2300 x 24 x 3</b> in black painted steel. 85 mm centre distance. Backset mm 35 * <b>7255013508</b> D	1	-	1
Flat front plate mm <b>2300 x 24 x 3</b> in black painted steel. 85 mm centre distance. Backset mm 40 * <b>7255014008</b> D	1	-	1
Flat front plate mm <b>2300 x 24 x 3</b> in black painted steel. 85 mm centre distance. Backset mm 45 * <b>7255014508</b> D	1	-	1
Flat front plate mm <b>2300 x 24 x 3</b> in black painted steel. 85 mm centre distance. Backset mm 50 * <b>7255015008</b> D	1	-	1

\* Available starting from the second half of 2010



## Perforza 85 mm centre distance

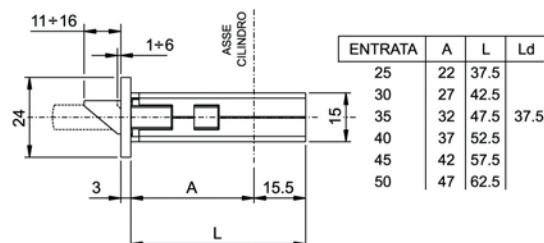
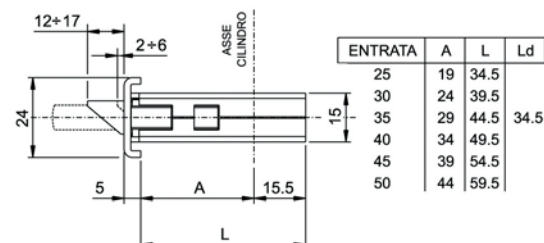
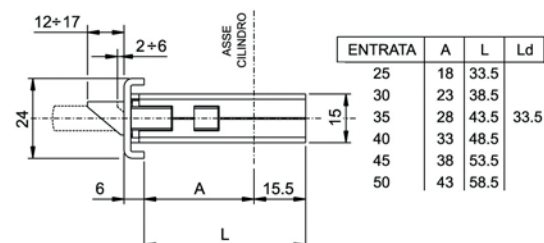
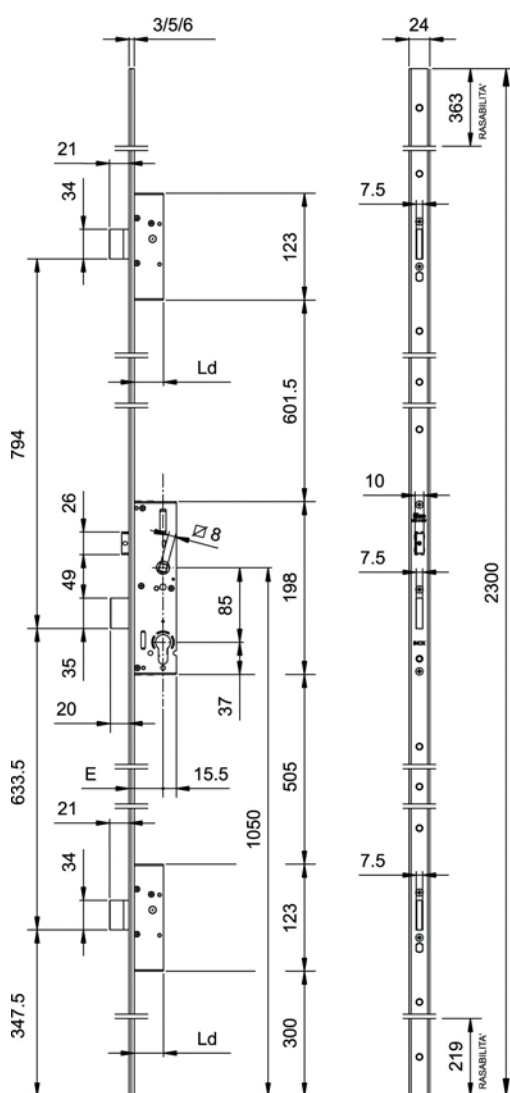
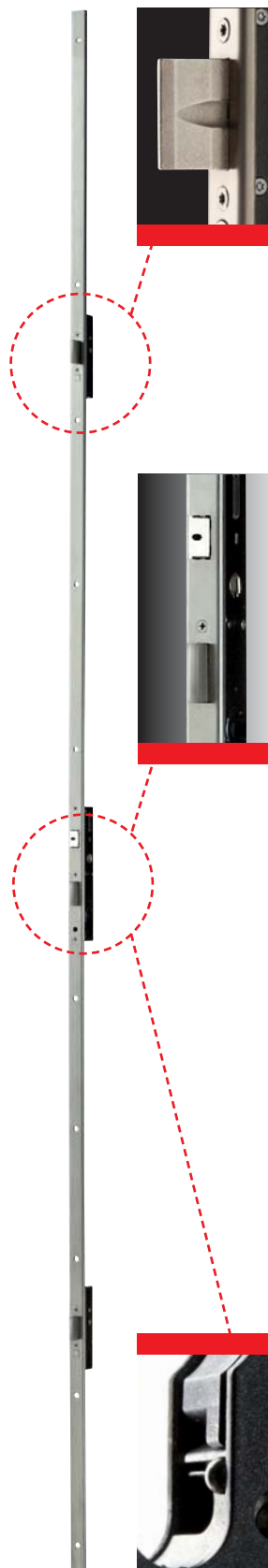

MULTIPOINT mortice lock for metal frames, 3-point locking,

### SLIDING DEADBOLT LOCK AND DEVIATORS.

Central lock, centre distance mm **85**, profile cylinder.

Throw mm 20, **reversible latchbolt**. The latchbolt can be replaced with roller or cap, mm 8 handle follower.

Closed case for lock and deviators.

2 nylon end blocks for U-version. Fixing screws. Instruction sheet.

The lock is equipped with a wheel-cam stopping device in case the cylinder is not assembled into the housing of lock.

### STAINLESS STEEL front plate.

#### Accessories to be ordered separately:

Roller FOR CENTRAL LOCK 040940

Cap for DEADBOLT only versions 040950

Striking plates

Electric strikers



Code

Status  
Single  
package

Multiple  
package

Min. ord.

**Perforza 85 mm centre distance**

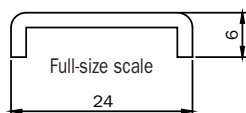

U-front plate mm <b>2300 x 24 x 6</b> in stainless steel. 85 mm centre distance. Backset mm 25 * <b>7235512528</b>	D	1	-	1
U-front plate mm <b>2300 x 24 x 6</b> in stainless steel. 85 mm centre distance. Backset mm 30 <b>7235513028</b>	D	1	-	1
U-front plate mm <b>2300 x 24 x 6</b> in stainless steel. 85 mm centre distance. Backset mm 35 <b>7235513528</b>	D	1	-	1
U-front plate mm <b>2300 x 24 x 6</b> in stainless steel. 85 mm centre distance. Backset mm 40 <b>7235514028</b>	D	1	-	1
U-front plate mm <b>2300 x 24 x 6</b> in stainless steel. 85 mm centre distance. Backset mm 45 <b>7235514528</b>	D	1	-	1
U-front plate mm <b>2300 x 24 x 6</b> in stainless steel. 85 mm centre distance. Backset mm 50 <b>7235515028</b>	D	1	-	1

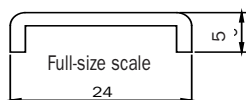

U-front plate mm <b>2300 x 24 x 5</b> in stainless steel. 85 mm centre distance. Backset mm 25 * <b>7235532528</b>	D	1	-	1
U-front plate mm <b>2300 x 24 x 5</b> in stainless steel. 85 mm centre distance. Backset mm 30 <b>7235533028</b>	D	1	-	1
U-front plate mm <b>2300 x 24 x 5</b> in stainless steel. 85 mm centre distance. Backset mm 35 <b>7235533528</b>	D	1	-	1
U-front plate mm <b>2300 x 24 x 5</b> in stainless steel. 85 mm centre distance. Backset mm 40 <b>7235534028</b>	D	1	-	1
U-front plate mm <b>2300 x 24 x 5</b> in stainless steel. 85 mm centre distance. Backset mm 45 <b>7235534528</b>	D	1	-	1
U-front plate mm <b>2300 x 24 x 5</b> in stainless steel. 85 mm centre distance. Backset mm 50 <b>7235535028</b>	D	1	-	1

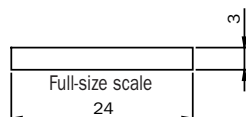

Flat front plate mm <b>2300 x 24 x 3</b> in stainless steel. 85 mm centre distance. Backset mm 25 * <b>7235012528</b>	D	1	-	1
Flat front plate mm <b>2300 x 24 x 3</b> in stainless steel. 85 mm centre distance. Backset mm 30 <b>7235013028</b>	D	1	-	1
Flat front plate mm <b>2300 x 24 x 3</b> in stainless steel. 85 mm centre distance. Backset mm 35 <b>7235013528</b>	D	1	-	1
Flat front plate mm <b>2300 x 24 x 3</b> in stainless steel. 85 mm centre distance. Backset mm 40 <b>7235014028</b>	D	1	-	1
Flat front plate mm <b>2300 x 24 x 3</b> in stainless steel. 85 mm centre distance. Backset mm 45 <b>7235014528</b>	D	1	-	1
Flat front plate mm <b>2300 x 24 x 3</b> in stainless steel. 85 mm centre distance. Backset mm 50 <b>7235015028</b>	D	1	-	1

\* Available starting from the second half of 2010



**Perforza 85 mm centre distance**

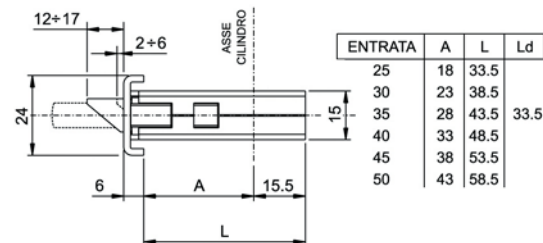
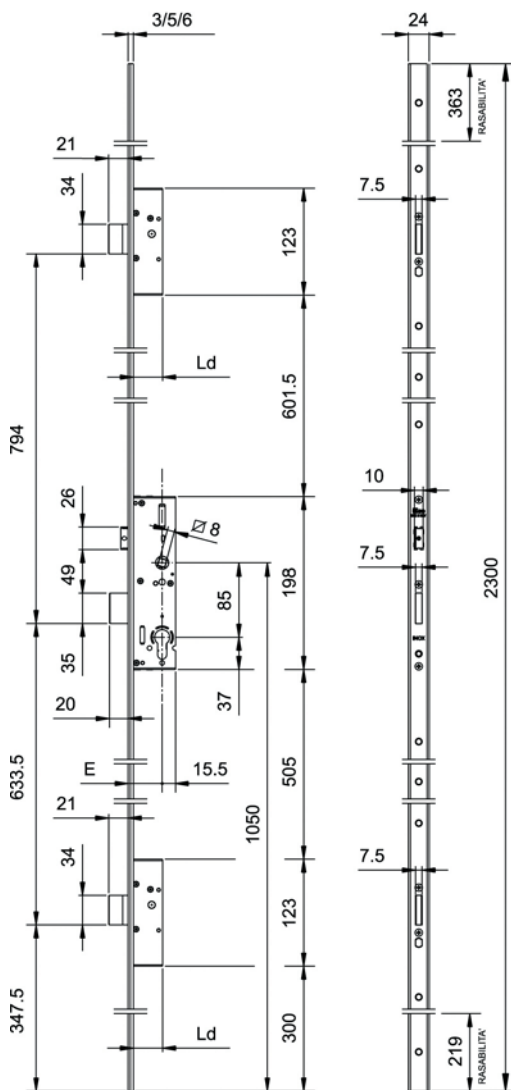
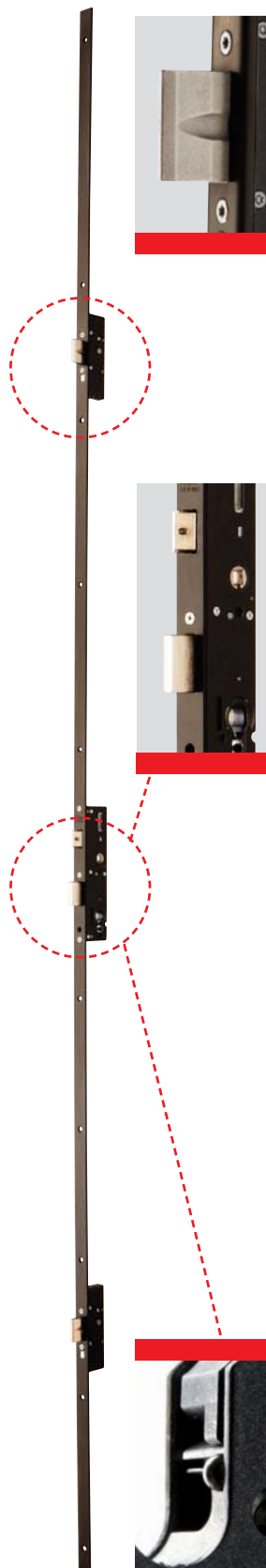

ENTRATA	A	L	Ld
25	18	33.5	
30	23	38.5	
35	28	43.5	33.5
40	33	48.5	
45	38	53.5	
50	43	58.5	

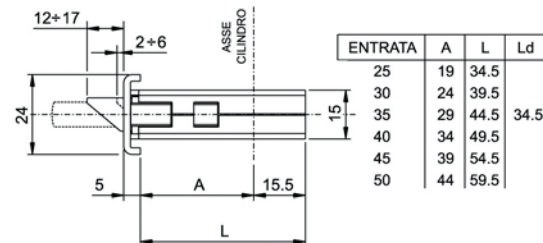

ENTRATA	A	L	Ld
25	19	34.5	
30	24	39.5	
35	29	44.5	34.5
40	34	49.5	
45	39	54.5	
50	44	59.5	

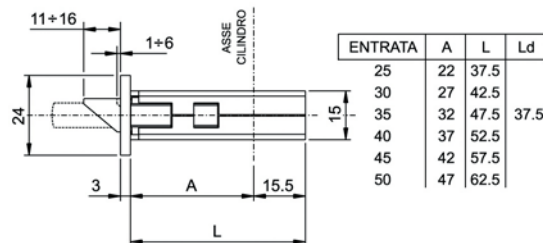

ENTRATA	A	L	Ld
25	22	37.5	
30	27	42.5	
35	32	47.5	37.5
40	37	52.5	
45	42	57.5	
50	47	62.5	

MULTIPOINT mortice lock for metal frames, 3-point locking,

**SLIDING DEADBOLT LOCK AND DEVIATORS.**

Central lock, centre distance mm **85**, profile cylinder.

Throw mm 20, **reversible latchbolt**. The latchbolt can be replaced with roller or cap, mm 8 handle follower.

Closed case for lock and deviators.

2 nylon end blocks for U-version. Fixing screws. Instruction sheet.

The lock is equipped with a wheel-cam stopping device in case the cylinder is not present into the housing of lock.

**Black painted steel front plate.**

**Accessories to be ordered separately:**

Roller FOR CENTRAL LOCK 040940

Cap for DEADBOLT only versions. 040950

Striking plates

Electric strikers



Code

Status  
Single  
package

Min. ord.

**Perforza 85 mm centre distance**

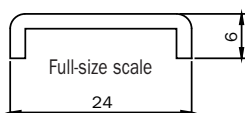

U-front plate mm <b>2300 x 24 x 6</b> in black painted steel. 85 mm centre distance. Backset mm 25* <b>7235512508</b>	D	1	-	1
U-front plate mm <b>2300 x 24 x 6</b> in black painted steel. 85 mm centre distance. Backset mm 30 <b>7235513008</b>	A	1	-	1
U-front plate mm <b>2300 x 24 x 6</b> in black painted steel. 85 mm centre distance. Backset mm 35 <b>7235513508</b>	A	1	-	1
U-front plate mm <b>2300 x 24 x 6</b> in black painted steel. 85 mm centre distance. Backset mm 40 <b>7235514008</b>	C	1	-	1
U-front plate mm <b>2300 x 24 x 6</b> in black painted steel. 85 mm centre distance. Backset mm 45 <b>7235514508</b>	D	1	-	1
U-front plate mm <b>2300 x 24 x 6</b> in black painted steel. 85 mm centre distance. Backset mm 50 <b>7235515008</b>	D	1	-	1

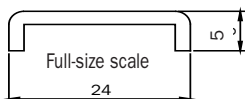

U-front plate mm <b>2300 x 24 x 5</b> in black painted steel. 85 mm centre distance. Backset mm 25* <b>7235532508</b>	D	1	-	1
U-front plate mm <b>2300 x 24 x 5</b> in black painted steel. 85 mm centre distance. Backset mm 30 <b>7235533008</b>	D	1	-	1
U-front plate mm <b>2300 x 24 x 5</b> in black painted steel. 85 mm centre distance. Backset mm 35 <b>7235533508</b>	D	1	-	1
U-front plate mm <b>2300 x 24 x 5</b> in black painted steel. 85 mm centre distance. Backset mm 40 <b>7235534008</b>	D	1	-	1
U-front plate mm <b>2300 x 24 x 5</b> in black painted steel. 85 mm centre distance. Backset mm 45 <b>7235534508</b>	D	1	-	1
U-front plate mm <b>2300 x 24 x 5</b> in black painted steel. 85 mm centre distance. Backset mm 50 <b>7235535008</b>	D	1	-	1

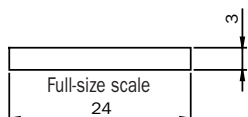

Flat front plate mm <b>2300 x 24 x 3</b> in black painted steel. 85 mm centre distance. Backset mm 25* <b>7235012508</b>	D	1	-	1
Flat front plate mm <b>2300 x 24 x 3</b> in black painted steel. 85 mm centre distance. Backset mm 30 <b>7235013008</b>	A	1	-	1
Flat front plate mm <b>2300 x 24 x 3</b> in black painted steel. 85 mm centre distance. Backset mm 35 <b>7235013508</b>	A	1	-	1
Flat front plate mm <b>2300 x 24 x 3</b> in black painted steel. 85 mm centre distance. Backset mm 40 <b>7235014008</b>	B	1	-	1
Flat front plate mm <b>2300 x 24 x 3</b> in black painted steel. 85 mm centre distance. Backset mm 45 <b>7235014508</b>	D	1	-	1
Flat front plate mm <b>2300 x 24 x 3</b> in black painted steel. 85 mm centre distance. Backset mm 50 <b>7235015008</b>	D	1	-	1

\* Available starting from the second half of 2010





**Perforza 92 mm centre distance**

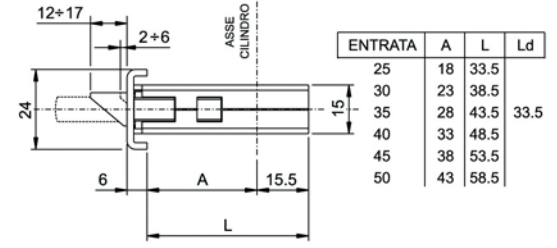
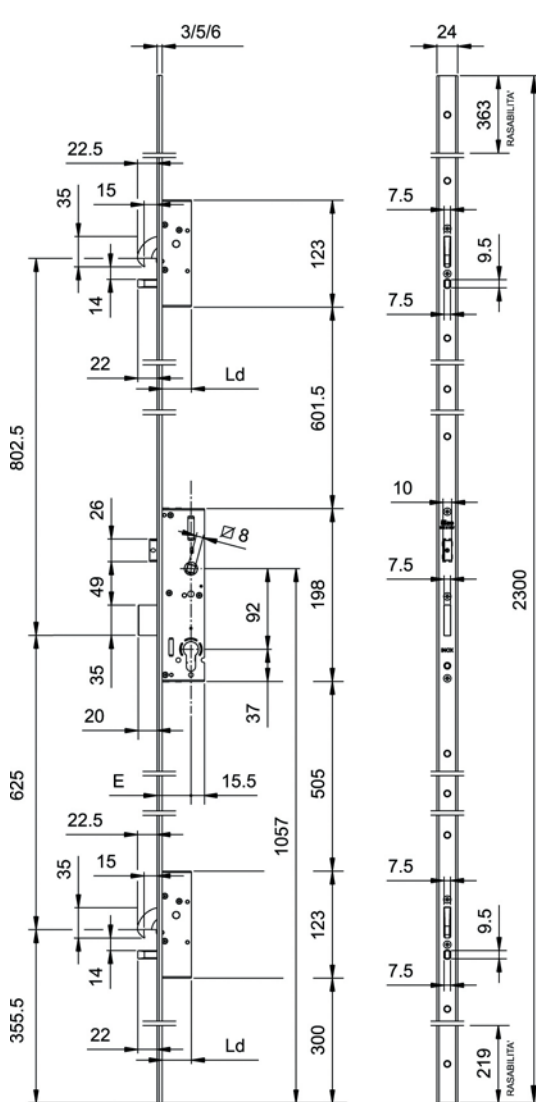
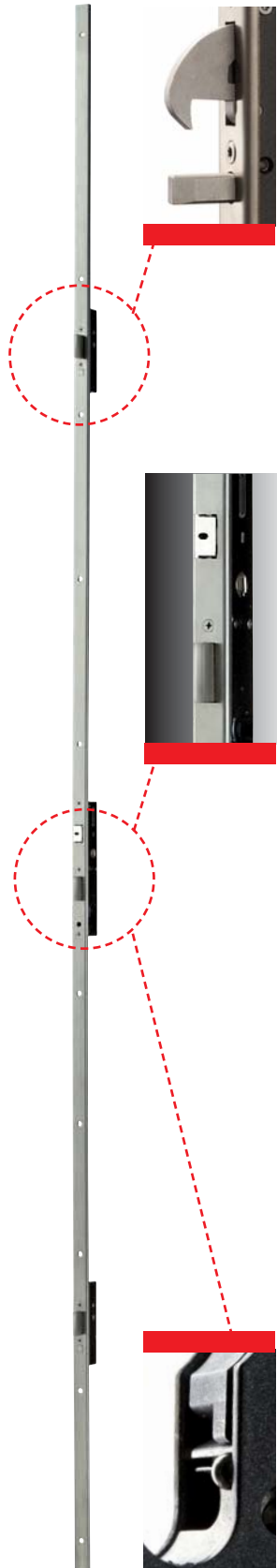

ENTRATA	A	L	Ld
25	18	33.5	33.5
30	23	38.5	
35	28	43.5	
40	33	48.5	
45	38	53.5	
50	43	58.5	

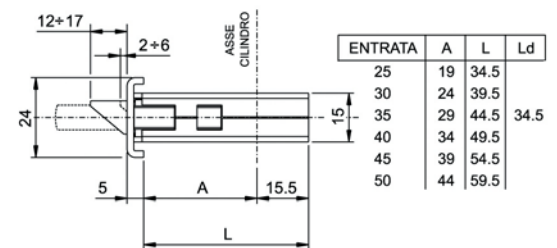

ENTRATA	A	L	Ld
25	19	34.5	34.5
30	24	39.5	
35	29	44.5	
40	34	49.5	
45	39	54.5	
50	44	59.5	

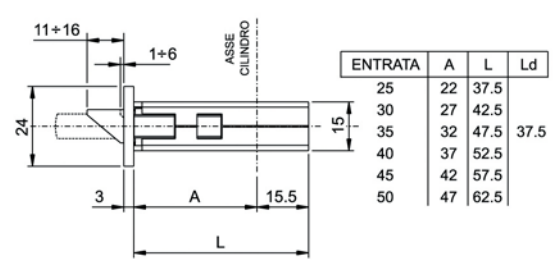

ENTRATA	A	L	Ld
25	22	37.5	37.5
30	27	42.5	
35	32	47.5	
40	37	52.5	
45	42	57.5	
50	47	62.5	

MULTIPOINT mortice lock for metal frames, 3-point locking,  
**ROTATING HOOK DEVIATORS AND SLIDING DEADBOLT LOCK**  
 Central lock, centre distance mm **92**, profile CYLINDER.  
 Throw mm 20, **reversible latchbolt**. The latchbolt can be replaced with roller or cap, mm 8 handle follower.  
 Closed case lock and deviators.  
 Connection cable, 2 nylon end blocks for U-version. Fixing screws. Instruction sheet.  
 The lock is equipped with a wheel-cam stopping device in case the cylinder is not present into the housing of lock.  
**Stainless steel front plate.**

- Accessories to be ordered separately:**  
 Roller for central lock 040940  
 Cap for latchbolty-only versions. 040950  
 Striking plates  
 Electric strikers





Code

Status  
Single  
package  
Multiple  
package  
Min. ord.

## Perforza 92 mm centre distance

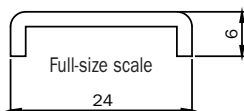

U-front plate mm <b>2300 x 24 x 6</b> in stainless steel. 92 mm centre distance. Backset mm 25*	<b>7252512528</b>	D	1	-	1
U-front plate mm <b>2300 x 24 x 6</b> in stainless steel. 92 mm centre distance. Backset mm 30*	<b>7252513028</b>	D	1	-	1
U-front plate mm <b>2300 x 24 x 6</b> in stainless steel. 92 mm centre distance. Backset mm 35*	<b>7252513528</b>	D	1	-	1
U-front plate mm <b>2300 x 24 x 6</b> in stainless steel. 92 mm centre distance. Backset mm 40*	<b>7252514028</b>	D	1	-	1
U-front plate mm <b>2300 x 24 x 6</b> in stainless steel. 92 mm centre distance. Backset mm 45*	<b>7252514528</b>	D	1	-	1
U-front plate mm <b>2300 x 24 x 6</b> in stainless steel. 92 mm centre distance. Backset mm 50*	<b>7252515028</b>	D	1	-	1

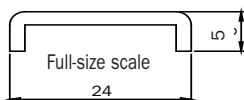

U-front plate mm <b>2300 x 24 x 5</b> in stainless steel. 92 mm centre distance. Backset mm 25*	<b>7252532528</b>	D	1	-	1
U-front plate mm <b>2300 x 24 x 5</b> in stainless steel. 92 mm centre distance. Backset mm 30*	<b>7252533028</b>	D	1	-	1
U-front plate mm <b>2300 x 24 x 5</b> in stainless steel. 92 mm centre distance. Backset mm 35*	<b>7252533528</b>	D	1	-	1
U-front plate mm <b>2300 x 24 x 5</b> in stainless steel. 92 mm centre distance. Backset mm 40*	<b>7252534028</b>	D	1	-	1
U-front plate mm <b>2300 x 24 x 5</b> in stainless steel. 92 mm centre distance. Backset mm 45*	<b>7252534528</b>	D	1	-	1
U-front plate mm <b>2300 x 24 x 5</b> in stainless steel. 92 mm centre distance. Backset mm 50*	<b>7252535028</b>	D	1	-	1

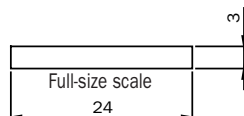

Flat front plate mm <b>2300 x 24 x 3</b> in stainless steel. 92 mm centre distance. Backset mm 25*	<b>7252012528</b>	D	1	-	1
Flat front plate mm <b>2300 x 24 x 3</b> in stainless steel. 92 mm centre distance. Backset mm 30*	<b>7252013028</b>	D	1	-	1
Flat front plate mm <b>2300 x 24 x 3</b> in stainless steel. 92 mm centre distance. Backset mm 35*	<b>7252013528</b>	D	1	-	1
Flat front plate mm <b>2300 x 24 x 3</b> in stainless steel. 92 mm centre distance. Backset mm 40*	<b>7252014028</b>	D	1	-	1
Flat front plate mm <b>2300 x 24 x 3</b> in stainless steel. 92 mm centre distance. Backset mm 45*	<b>7252014528</b>	D	1	-	1
Flat front plate mm <b>2300 x 24 x 3</b> in stainless steel. 92 mm centre distance. Backset mm 50*	<b>7252015028</b>	D	1	-	1

\* Available starting from the second half of 2010



**Perforza 92 mm centre distance**

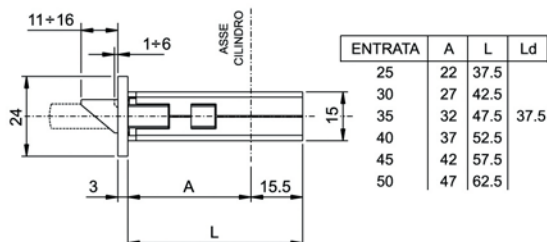
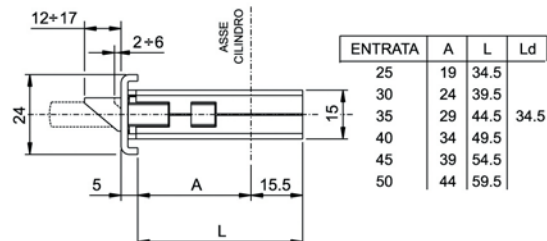
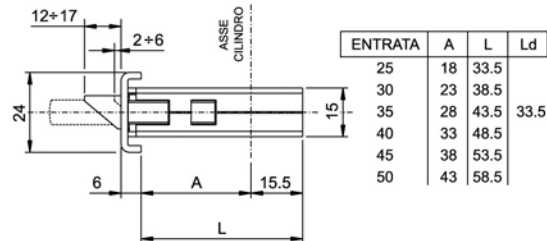
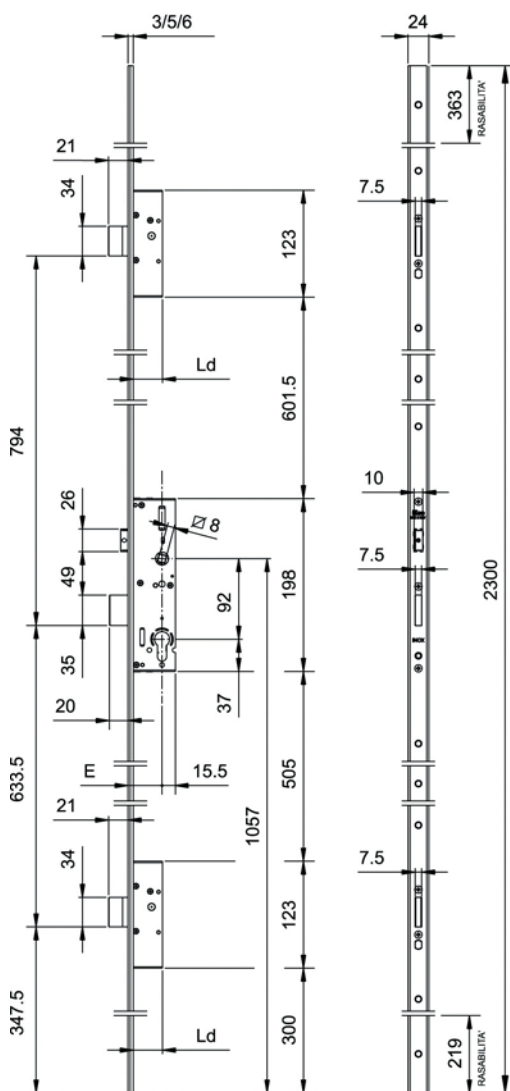
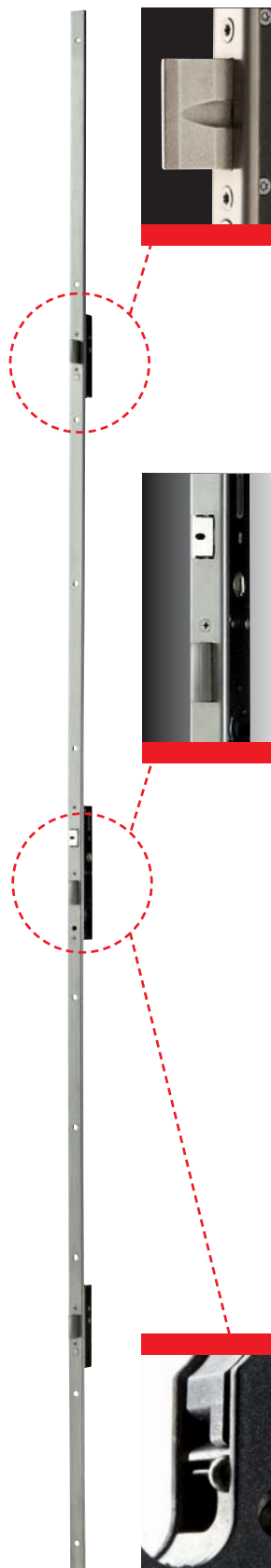

MULTIPOINT mortice lock for metal frames, 3-point locking,

**SLIDING DEADBOLT LOCK AND DEVIATORS.**

Central lock, centre distance mm **92**, profile cylinder .

Throw mm 20, **reversible latchbolt**. The latchbolt can be replaced with roller or cap, mm 8 handle follower.

Closed case for lock and deviators.

2 nylon end blocks for U-version. Fixing screws. Instruction sheet.

The lock is equipped with a wheel-cam stopping device in case the cylinder is not present into the housing of lock.

**Stainless steel front plate.**

**Accessories to be ordered separately:**

Roller FOR CENTRAL LOCK 040940

Cap for DEADBOLT only versions 040950

Striking plates

Electric strikers



Code

Status  
Single  
package  
Multiple  
package  
Min. ord.

## Perforza 92 mm centre distance

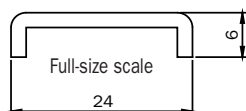

U-front plate mm <b>2300 x 24 x 6</b> in stainless steel. 92 mm centre distance. Backset mm 25 * <b>7232512528</b>	D	1	-	1
U-front plate mm <b>2300 x 24 x 6</b> in stainless steel. 92 mm centre distance. Backset mm 30 <b>7232513028</b>	D	1	-	1
U-front plate mm <b>2300 x 24 x 6</b> in stainless steel. 92 mm centre distance. Backset mm 35 <b>7232513528</b>	D	1	-	1
U-front plate mm <b>2300 x 24 x 6</b> in stainless steel. 92 mm centre distance. Backset mm 40 <b>7232514028</b>	D	1	-	1
U-front plate mm <b>2300 x 24 x 6</b> in stainless steel. 92 mm centre distance. Backset mm 45 * <b>7232514528</b>	D	1	-	1
U-front plate mm <b>2300 x 24 x 6</b> in stainless steel. 92 mm centre distance. Backset mm 50 * <b>7232515028</b>	D	1	-	1

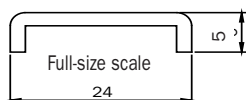

U-front plate mm <b>2300 x 24 x 5</b> in stainless steel. 92 mm centre distance. Backset mm 25 * <b>7232532528</b>	D	1	-	1
U-front plate mm <b>2300 x 24 x 5</b> in stainless steel. 92 mm centre distance. Backset mm 30 <b>7232533028</b>	D	1	-	1
U-front plate mm <b>2300 x 24 x 5</b> in stainless steel. 92 mm centre distance. Backset mm 35 <b>7232533528</b>	D	1	-	1
U-front plate mm <b>2300 x 24 x 5</b> in stainless steel. 92 mm centre distance. Backset mm 40 <b>7232534028</b>	D	1	-	1
U-front plate mm <b>2300 x 24 x 5</b> in stainless steel. 92 mm centre distance. Backset mm 45 * <b>7232534528</b>	D	1	-	1
U-front plate mm <b>2300 x 24 x 5</b> in stainless steel. 92 mm centre distance. Backset mm 50 * <b>7232535028</b>	D	1	-	1

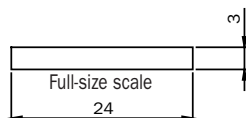

Flat front plate mm <b>2300 x 24 x 3</b> in stainless steel. 92 mm centre distance. Backset mm 25 * <b>7232012528</b>	D	1	-	1
Flat front plate mm <b>2300 x 24 x 3</b> in stainless steel. 92 mm centre distance. Backset mm 30 <b>7232013028</b>	D	1	-	1
Flat front plate mm <b>2300 x 24 x 3</b> in stainless steel. 92 mm centre distance. Backset mm 35 <b>7232013528</b>	D	1	-	1
Flat front plate mm <b>2300 x 24 x 3</b> in stainless steel. 92 mm centre distance. Backset mm 40 <b>7232014028</b>	D	1	-	1
Flat front plate mm <b>2300 x 24 x 3</b> in stainless steel. 92 mm centre distance. Backset mm 45 * <b>7232014528</b>	D	1	-	1
Flat front plate mm <b>2300 x 24 x 3</b> in stainless steel. 92 mm centre distance. Backset mm 50 * <b>7232015028</b>	D	1	-	1



Code

Status

Single  
package

Multiple  
package

Min. ord.

## **Perforza Accessories**

### **Accessories for central lock to be ordered separately**



ROLLER KIT for PERFORMA, WITH NYLON INSERTS

It can replace the latchbolt

For lock backset mm 25, 30, 35, 40, 45, 50

**040940** A 10 - 10



CAP KIT PERFORMA

It can replace the latchbolt for DEADBOLTS only version.

For lock backset mm 25, 30, 35, 40, 45, 50

**040950** B 10 - 10



Code

Status

Single  
package

Multiple  
package

Min. ord.

**Perforza Options**

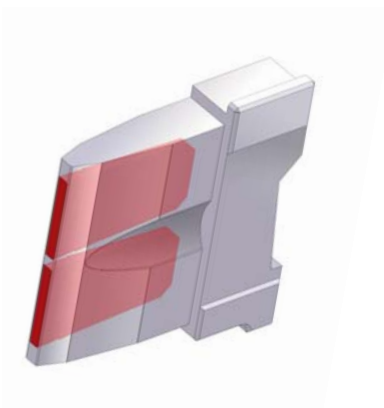
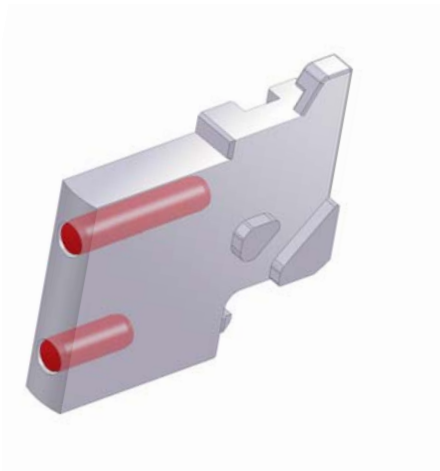

**DEVIATORS AND LOCK WITH SLIDING DEADBOLTS, STAINLESS STEEL FRONT PLATE.**

**ANTI-SAW DEADBOLTS REINFORCED. 85 mm centre distance LOCK**

U-front plate mm <b>2300 x 24 x 6</b> in stainless steel. 85 mm centre distance. Backset mm **	<b>723651**28</b>	D	1	-	1
U-front plate mm <b>2300 x 24 x 5</b> in stainless steel. 85 mm centre distance. Backset mm **	<b>723653**28</b>	D	1	-	1
Flat front plate mm <b>2300 x 24 x 3</b> in stainless steel. 85 mm centre distance. Backset mm **	<b>723601**28</b>	D	1	-	1

**ANTI-SAW DEADBOLTS REINFORCED. 92 mm centre distance LOCK**

U-front plate mm <b>2300 x 24 x 6</b> in stainless steel. 92 mm centre distance. Backset mm **	<b>723351**28</b>	D	1	-	1
U-front plate mm <b>2300 x 24 x 5</b> in stainless steel. 92 mm centre distance. Backset mm **	<b>723353**28</b>	D	1	-	1
Flat front plate mm <b>2300 x 24 x 3</b> in stainless steel. 92 mm centre distance. Backset mm **	<b>723301**28</b>	D	1	-	1

\*\* = Backset mm 25/30/35/40/45/50

Availability and delivery to be agreed

**For locks for metal frames series 72\***



Code

Status  
Single package

Min. ord.

**Perforza**

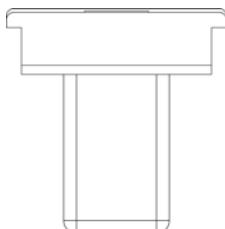

Full-size scale

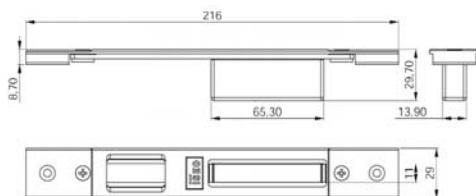

- ALCAN abithal Keeper Porta 53-60 / Abithal Keeper Porta 61-68  
Abithal Porta / Winner Porta
- ALCOA fb 12 Blindato / Formula F40 Porta / Formula F40 Tt Porta  
Formula F50 Porta / Formula F50 Tt Porta / Formula F60 Tt Porta  
Plana 1 Anta / Plana 2 Ante
- ALLCO all.Co 5 Porta / All.Co 5 Tt Porta / Export 50 Porta  
Export 50 Tt Porta / Sicurblin 65
- ALNOR montreal Porta
- ALU-K alubindo / N 45 Porta / N 53 Porta / N 55 Tt Porta  
N 62 Tt Porta
- ALU-MEC synthesis 57 Porta / Synthesis 60Tt Porta
- ALUSUISSE alsec 2000 Porta 59 / Alsec 2000 Porta 69
- BODEGA extrabind 70
- DOMAL domal Break 52 Porta / Domal Break 70 Porta  
Domal Security Porta / Domal Shops Porta / Domal Stopper Pg Porta
- ESA blindal 60 Porta 1 Anta / Blindal 60 Porta 2 Ante  
Blindal 70 Porta 1 Anta / Blindal 70 Porta 2 Ante
- FRESIA global 48 Porta
- INDIVEST alpha 445 Porta 2 Ante
- METRA nc 45 International Porta / Nc 45 Superthermic Porta  
Nc 55 International Porta / Nc 68 Superthermic Porta  
Nuovo Nc 50 Porta / Superblindo
- NEW TEC new Tec 50 Porta Complanare  
New Tec 52 Tt Porta Complanare / New Tec 68 Tt Porta  
Complanare
- OCMAfc 60 Tt Porta / Sv 47 Porta 1 Anta / Sv 47 Porta 2 Ante  
Sv 62 Porta 1 Anta / Sv 62 Porta 2 Ante / Sv 62 Tt Porta 1 Anta  
Sv 62 Tt Porta 2 Ante
- PASSERINI ekip Blindo / Ekip Maastricht 53 Porta 1 Anta  
Ekip Maastricht 53 Porta 2 Ante  
Ekip Maastricht Th 60 Porta 1 Anta  
Ekip Maastricht Th 60 Porta 2 Ante  
Ekip Maastricht Th 68 Porta 1 Anta  
Ekip Maastricht Th 68 Porta 2 Ante / Ekip Thermo 53 Porta
- PROFILATI "Pe" "Eku 53" "Porta"  
"Pe" "Eku 64 Tt" "Porta"  
"Pe" "Eku 72 Tt" "Porta"
- SCHÜCO royal 78 St Blindato / Royal S 50 N / Royal S 55 Tt  
Royal S 65 Tt
- WICONA 160A / L70A

**ADJUSTABLE** closed striking plate for **CENTRAL LOCK** PERFORMA, all versions. Black-painted steel.

Flat front plate **29x216**  
with vertical adjustment from 7 to 12 mm  
and horizontal adjustment  $\pm$  mm 2.

**038620** A 10 - 10

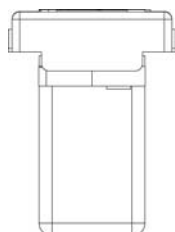

Full-size scale

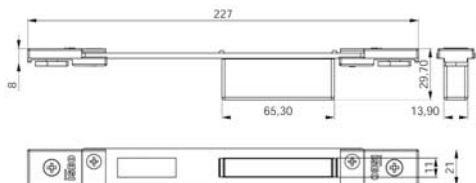

- ALCAN abithal Cristal / Abithal Keeper Porta C.E. / Winner Finestra
- ALCOA fb 12 Ga / Europa Ga / Fo 12 T.T. / R 35 Reversible  
R 35 Sormonto
- ALLCO export 40 Finestra / Export 45 Tt Finestra / Export 50  
Finestra  
Export 50 Tt Finestra / Final 40 Finestra / Sicurblin C.E.
- ALU-MEC synthesis 45 Finestra / Synthesis 57 Finestra  
Synthesis 60 Tt Finestra
- ALUSUISSE alsec 2000 Finestra 59 / Alsec 2000 Finestra 69
- BODEGA bga 50 / New Bt 60
- DOMAL domal Break 52 Finestra / Domal Break 70 Finestra  
Domal Stopper Pg Finestra
- EQUIPE sistema 8000 G.A. Finestra 1 Anta  
Sistema 8000 G.A. Finestra 2 Ante / Sistema 8000 Tt Finestra 1  
Anta  
Sistema 8000 Tt Finestra 2 Ante
- ESA isola Porta
- ESEDRA ga 53 Porta / Tt 63 Porta / Tt 75 Porta
- INDIVEST gold 400 Complanare / Gold 400 Sormonto  
Gold 500 Complanare / Gold 500 Sormonto / Gold 600 Complanare  
Gold 600 Sormonto
- METRA nc 45 International Finestra / Nc 45 Superthermic Finestra  
Nc 55 International Finestra / Nc 68 Superthermic Finestra  
Nuovo Nc 40 Sorm. 2 Ante Con Riporto / Nuovo Nc 40 Sormonto 1  
Anta
- MORELLI ma 8300
- OCMA fc 47 Finestra / Fc 55 Finestra / Fc 60 Tt Finestra
- PASSERINI ekip 40 Evoluzione 1 Anta / Ekip 40 Evoluzione 2 Ante  
Ekip 40 Sormonto 1 Anta / Ekip 40 Sormonto 2 Ante  
Ekip Maastricht 53 Finestra / Ekip Maastricht Th 60 Finestra  
Ekip Maastricht Th 68 Finestra
- PROFILATI "Pe" "Eku 53" "Finestra" / "Pe" "Eku 64 Tt" "Finestra"  
"Pe" "Eku 72 Tt" "Finestra" / Sistema 1 Pe 40 Comp./Est. 1 Anta  
Sistema 1 Pe 40 Sormonto 1 Anta / Sistema 1 Pe 50 Comp./Est. 1  
Anta  
Sistema 1 Pe 50 Sormonto 1 Anta

**ADJUSTABLE** closed striking plate for **CENTRAL LOCK** PERFORMA, all versions. Black-painted steel.

Flat front plate **22x227**  
with vertical adjustment through threaded plates  
and horizontal adjustment  $\pm$  mm 9.

**038621** A 10 - 10

For locks for metal frames  
series 72\*



Code

Status  
Single  
package

Min. ord.

## Perforza

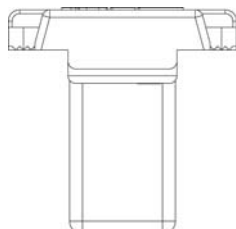

Full-size scale

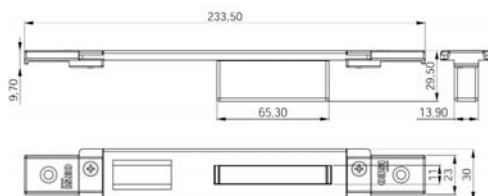

ALCOA alubind / R 40 Reversibile 1 Anta / R 40 Reversibile 2 Anta  
R 40 Sormonto 1 Anta / R 40 Sormonto 2 Ante  
R 50 Sormonto 1 Anta / R 50 Sormonto 2 Ante  
R 50 Tt Sormonto 1 Anta / R 50 Tt Sormonto 2 Ante  
R 60 Tt Complanare  
ALL.CO all.Co 5 Reversibile / All.Co 5 Sormonto / ltes P4 Sormonto  
ALU-K n 45 Reversibile  
ESA giuntall Porta  
FRESIA global 41 Complanare / Global 41 Sormonto  
Global 48 Complanare / Global 48 Sormonto / Global 70 Taglio  
Termico  
METRA nuovo Nc 50 Sormonto 1 Anta / Nuovo Nc 50 Sormonto 2 Ante  
New Tecnew Tec 50 Porta Sormonto / New Tec 52 Tt Porta Sormonto  
New Tec 60 Tt Porta Sormonto / New Tec 68 Tt Porta Sormonto  
PASSERINI ekip 50 Sormonto 1 Anta / Ekip 50 Sormonto 2 Ante

**ADJUSTABLE** closed striking plate for **CENTRAL LOCK**  
PERFORMA, all versions. Black-painted zamak.

Flat front plate **30x5,1x233,5**  
horizontal adjustment  $\pm 9$  mm

038622 B 10 - 10

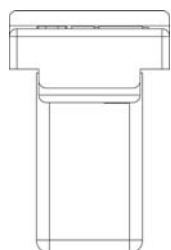

Full-size scale

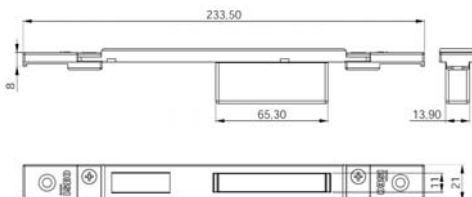

ALL.CO all.Co 5 Complanare / ltes P4 Complanare  
ALNOR blindo Block / Montreal G.A.  
ALU-K n 53 Complanare / N 55 Tt Complanare  
ESA giuntall Complanare  
INDINVEST alpha 255 Complanare / Alpha 370 Tt Complanare  
Alpha 445 Finestra / Alpha 445 Porta 1 Anta  
Alpha 658 Tt Complanare / Alpha Blitz 2000  
Alpha Globo 45 / Alpha Globo 55  
METRA nuovo Nc 40 Complanare / Nuovo Nc 40 Sormonto 2 Ante  
Nuovo Nc 50 Complanare  
PASSERINI ekip 40 Complanare 1 Anta  
Ekip 40 Complanare 2 Ante  
Ekip 50 Complanare 1 Anta / Ekip 50 Complanare 2 Ante  
Ekip Thermo 53 Finestra 1 Anta / Ekip Thermo 53 Finestra 2 Ante  
Ekip Thermo 58 Finestra 1 Anta / Ekip Thermo 58 Finestra 2 Ante  
PROFILATI sistema 1 Pe 40 Comp./Est. 2 Ante  
Sistema 1 Pe 40 Sormonto 2 Ante / Sistema 1 Pe 50 Comp.  
Est. 2 Ante  
Sistema 1 Pe 50 Sormonto 2 Ante

**ADJUSTABLE** closed striking plate for **CENTRAL LOCK**  
PERFORMA, all versions. Black-painted zamak.

Flat front plate **21x8x233,5**  
horizontal adjustment  $\pm 9$  mm

038623 D 10 - 10

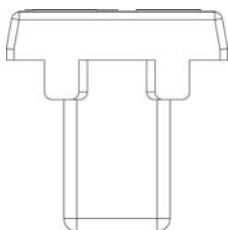

Full-size scale

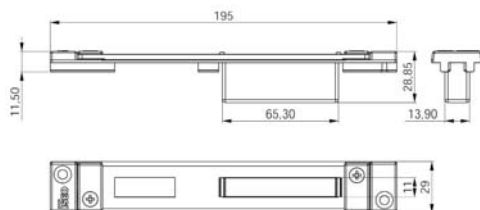

ALCOA alubind / R 40 Reversibile 1 Anta  
R 40 Reversibile 2 Ante  
R 40 Sormonto 1 Anta / R 40 Sormonto 2 Ante  
R 50 Sormonto 1 Anta / R 50 Sormonto 2 Ante  
R 50 Tt Sormonto 1 Anta / R 50 Tt Sormonto 2 Ante  
R 60 Tt Complanare

**ADJUSTABLE** closed striking plate for **CENTRAL LOCK**  
PERFORMA, all versions. Black-painted steel.

Flat front plate **29x195**  
horizontal adjustment  $\pm 13$  mm

038624 A 10 - 10

For locks for metal frames series 72\*



Code

Status

Single package

Multiple package

Min. ord.

Perforza

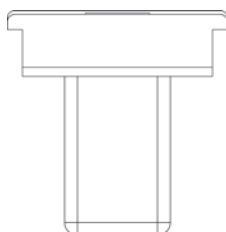

Full-size scale

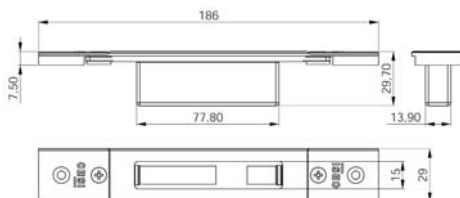

- ALCAN abithal Keeper Porta 53-60 / Abithal Keeper Porta 61-68 Abithal Porta / Winner Porta
- ALCOA fb 12 Blindato / Formula F40 Porta / Formula F40 Tt Porta Formula F50 Porta / Formula F50 Tt Porta / Formula F60 Tt Porta Plana 1 Anta / Plana 2 Ante
- ALLCO all.Co 5 Porta / All.Co 5 Tt Porta / Export 50 Porta Export 50 Tt Porta / Sicurlin 65
- ALNOR montreal Porta
- ALU-K alublindo / N 45 Porta / N 53 Porta / N 55 Tt Porta N 62 Tt Porta
- ALU-MEC synthesis 57 Porta / Synthesis 60Tt Porta
- ALUSUISSE alsec 2000 Porta 59 / Alsec 2000 Porta 69
- BODEGA extrablind 70
- DOMAL domal Break 52 Porta / Domal Break 70 Porta Domal Security Porta / Domal Shops Porta / Domal Stopper Pg Porta
- ESA blindal 60 Porta 1 Anta / Blindal 60 Porta 2 Ante Blindal 70 Porta 1 Anta / Blindal 70 Porta 2 Ante
- FRESIA global 48 Porta
- INDIVEST alpha 445 Porta 2 Ante
- METRA nc 45 International Porta / Nc 45 Superthermic Porta Nc 55 International Porta / Nc 68 Superthermic Porta Nuovo Nc 50 Porta / Superblindo
- NEW TEC new Tec 50 Porta Complanare New Tec 52 Tt Porta Complanare / New Tec 68 Tt Porta Complanare
- OCMAfc 60 Tt Porta / Sv 47 Porta 1 Anta / Sv 47 Porta 2 Ante Sv 62 Porta 1 Anta / Sv 62 Porta 2 Ante / Sv 62 Tt Porta 1 Anta Sv 62 Tt Porta 2 Ante
- PASSERINI ekip Blindo / Ekip Maastricht 53 Porta 1 Anta Ekip Maastricht 53 Porta 2 Ante / Ekip Maastricht Th 60 Porta 1 Anta Ekip Maastricht Th 60 Porta 2 Ante Ekip Maastricht Th 68 Porta 1 Anta Ekip Maastricht Th 68 Porta 2 Ante / Ekip Thermo 53 Porta
- PROFILATI "Pe" "Eku 53" "Porta" "Pe" "Eku 64 Tt" "Porta" "Pe" "Eku 72 Tt" "Porta"
- SCHÜCO royal 78 St Blindato / Royal S 50 N / Royal S 55 Tt Royal S 65 Tt
- WICONA i60A / L70A

ADJUSTABLE closed striking plate for DEVIATORS

PERFORMA. Black-painted steel.

Flat front plate 29x186

with vertical adjustment from 7 to 12 mm

and horizontal adjustment ± 2mm

038720 A 10 - 10

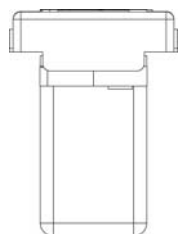

Full-size scale

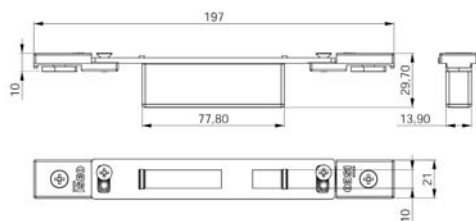

- ALCAN abithal Cristal / Abithal Keeper Porta C.E. / Winner Finestra
- ALCOA fo 12 Ga / Europa Ga / Fo 12 T.T. / R 35 Reversibile R 35 Sormonto
- ALLCO export 40 Finestra / Export 45 Tt Finestra / Export 50 Finestra Export 50 Tt Finestra / Final 40 Finestra / Sicurlin C.E.
- ALU-MEC synthesis 45 Finestra / Synthesis 57 Finestra Synthesis 60 Tt Finestra
- ALUSUISSE alsec 2000 Finestra 59 / Alsec 2000 Finestra 69
- BODEGA lga 50 / New Bt 60
- DOMAL domal Break 52 Finestra / Domal Break 70 Finestra Domal Stopper Pg Finestra
- EQUIPE sistema 8000 G.A. Finestra 1 Anta Sistema 8000 G.A. Finestra 2 Ante / Sistema 8000 Tt Finestra 1 Anta Sistema 8000 Tt Finestra 2 Ante
- ESA Isola Porta
- ESEDRA ga 53 Porta / Tt 63 Porta / Tt 75 Porta
- INDIVEST gold 400 Complanare / Gold 400 Sormonto Gold 500 Complanare / Gold 500 Sormonto / Gold 600 Complanare Gold 600 Sormonto
- METRA nc 45 International Finestra / Nc 45 Superthermic Finestra Nc 55 International Finestra / Nc 68 Superthermic Finestra Nuovo Nc 40 Sorm. 2 Ante Con Riporto Nuovo Nc 40 Sormonto 1 Anta
- MORELLI ma 8300
- OCMA fo 47 Finestra / Fo 55 Finestra / Fo 60 Tt Finestra
- PASSERINI ekip 40 Evoluzione 1 Anta / Ekip 40 Evoluzione 2 Ante Ekip 40 Sormonto 1 Anta / Ekip 40 Sormonto 2 Ante Ekip Maastricht 53 Finestra / Ekip Maastricht Th 60 Finestra Ekip Maastricht Th 68 Finestra
- PROFILATI "Pe" "Eku 53" "Finestra" / "Pe" "Eku 64 Tt" "Finestra" "Pe" "Eku 72 Tt" "Finestra" / Sistema 1 Pe 40 Comp./Est. 1 Anta Sistema 1 Pe 40 Sormonto 1 Anta / Sistema 1 Pe 50 Comp./Est. 1 Anta Sistema 1 Pe 50 Sormonto 1 Anta

ADJUSTABLE closed striking plate for DEVIATORS

PERFORMA, Black-painted steel.

Flat front plate 22x197

with vertical adjustment through threaded plates

and horizontal adjustment ± 9 mm

038721 A 10 - 10



For locks for metal frames series 72\*



Code

Status  
Single package

Min. ord.

## Perforza



Full-size scale

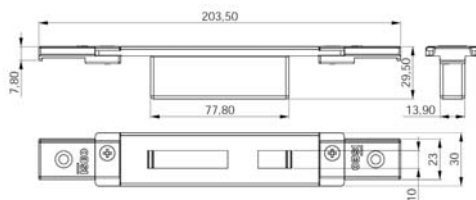

**ADJUSTABLE** closed striking plate for **DEVIATORS**

PERFORMA. Black-painted zamak.

Flat front plate **30x5,5x203,5**

horizontal adjustment  $\pm 9$  mm

ALCOA alubind / R 40 Reversibile 1 Anta / R 40 Reversibile 2 Anta  
R 40 Sormonto 1 Anta / R 40 Sormonto 2 Anta  
R 50 Sormonto 1 Anta / R 50 Sormonto 2 Anta  
R 50 Tt Sormonto 1 Anta / R 50 Tt Sormonto 2 Anta  
R 60 Tt Complanare  
ALL.CO all.Co 5 Reversibile / All.Co 5 Sormonto / Ites P4 Sormonto  
ALU-K n 45 Reversibile  
ESA giuntall Porta  
FRESIA global 41 Complanare / Global 41 Sormonto  
Global 48 Complanare / Global 48 Sormonto / Global 70 Taglio Termico  
METRA nuovo Nc 50 Sormonto 1 Anta / Nuovo Nc 50 Sormonto 2 Anta  
New Tecnew Tec 50 Porta Sormonto / New Tec 52 Tt Porta Sormonto  
New Tec 60 Tt Porta Sormonto / New Tec 68 Tt Porta Sormonto  
PASSERINI ekip 50 Sormonto 1 Anta / Ekip 50 Sormonto 2 Anta

**038722** D 10 - 10

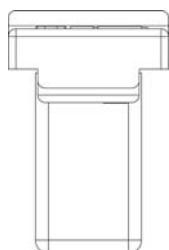

Full-size scale

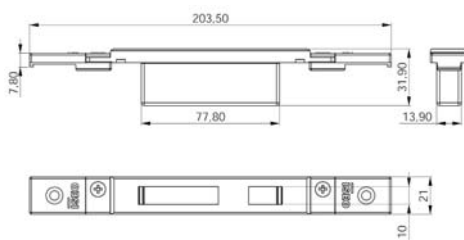

**ADJUSTABLE** closed striking plate for **DEVIATORS**

PERFORMA. Black-painted zamak.

Flat front plate **21x8x203,5**

horizontal adjustment  $\pm 9$  mm

ALL.CO all.Co 5 Complanare / Ites P4 Complanare  
ALNOR blindo Block / Montreal G.A.  
ALU-K n 53 Complanare / N 55 Tt Complanare  
ESA giuntall Complanare  
INDINVEST alpha 255 Complanare / Alpha 370 Tt Complanare  
Alpha 445 Finestra / Alpha 445 Porta 1 Anta  
Alpha 658 Tt Complanare / Alpha Blitz 2000  
Alpha Globo 45 / Alpha Globo 55  
METRA nuovo Nc 40 Complanare / Nuovo Nc 40 Sormonto 2 Anta  
Nuovo Nc 50 Complanare  
PASSERINI ekip 40 Complanare 1 Anta / Ekip 40 Complanare 2 Anta  
Ekip 50 Complanare 1 Anta / Ekip 50 Complanare 2 Anta  
Ekip Thermo 53 Finestra 1 Anta / Ekip Thermo 53 Finestra 2 Anta  
Ekip Thermo 58 Finestra 1 Anta / Ekip Thermo 58 Finestra 2 Anta  
PROFILATI sistema 1 Pe 40 Comp./Est. 2 Anta  
Sistema 1 Pe 40 Sormonto 2 Anta  
Sistema 1 Pe 50 Comp./Est. 2 Anta  
Sistema 1 Pe 50 Sormonto 2 Anta

**038723** D 10 - 10

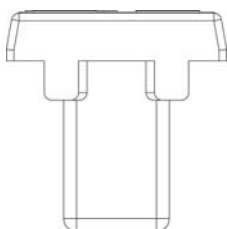

Full-size scale

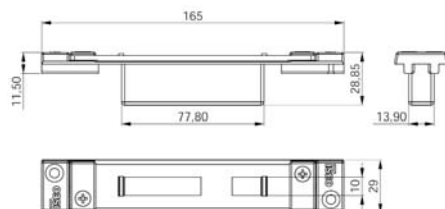

**ADJUSTABLE** closed striking plate for **DEVIATORS**

PERFORMA. Black-painted steel.

Flat front plate **29x165**

horizontal adjustment  $\pm 13$  mm

ALCOA alubind / R 40 Reversibile 1 Anta  
R 40 Reversibile 2 Anta  
R 40 Sormonto 1 Anta / R 40 Sormonto 2 Anta  
R 50 Sormonto 1 Anta / R 50 Sormonto 2 Anta  
R 50 Tt Sormonto 1 Anta / R 50 Tt Sormonto 2 Anta  
R 60 Tt Complanare

**038724** A 10 - 10

**For locks for metal frames series 72\***



Code

Min. ord.  
Multiple package  
Single package  
Status

**Perforza**



Full-size scale

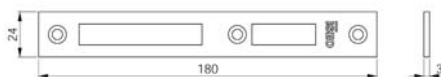

**ALCOA** Fb 12 Blindato  
Fb 12 Trad./Revamping  
Gr 9  
Plana 1 Anta  
**ESA** Blindal 60 Porta 1 Anta  
Blindal 60 Porta 2 Ante  
**ESA** Blindal 70 Porta 1 Anta  
Blindal 70 Porta 2 Ante  
**SCHUCO** Royal S 50 N  
Royal S 55 Tt  
Royal S 65 Tt

Striking plates

**FOR CENTRAL LOCK PERFORMA.**

Stainless steel. Flat front plate **24x3x180.**

**038230** C 10 - 10

Nickel plated. Flat front plate **24x3x180.**

**038230H3** D 10 - 10



Full-size scale

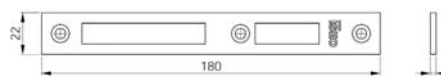

**Alcan** Abithal Cristal / Abithal Keeper Porta C.E.  
Winner Finestra  
**Alcoa** Fb 12 Ga / Europa Ga / Fb 12 T.T. / R 35 Reversibile  
R 35 Sormonto  
**All.Co** Export 40 Finestra / Export 50 Finestra  
Export 50 Tt Finestra / Final 40 Finestra / Sicurblin C.E.  
**Alu-mec** Synthesis 45 Finestra / Synthesis 57 Finestra  
Synthesis 60 Tt Finestra  
**Alusuisse** Alsec 2000 Finestra 59 / Alsec 2000 Finestra 69  
**Bodega** Bga 50 / New Bt 60  
**Domal** Domal Break 52 Finestra / Domal Break 70 Finestra  
Domal Stopper Pg Finestra  
**Equipe** Sistema 8000 G.A. Finestra 1 Anta  
Sistema 8000 G.A. Finestra 2 Ante  
**Esa** Isola Porta  
**Esedra** Ga 53 Porta / Ga 53 Porta / Tt 63 Porta / Tt 63 Porta  
Tt 75 Porta / Tt 75 Porta  
**Indinvest** Gold 400 Complanare / Gold 400 Sormonto  
Gold 500 Complanare / Gold 500 Sormonto  
Gold 600 Complanare / Gold 600 Sormonto  
**Metra** Nc 45 International Finestra / Nc 45 Superthermic Finestra  
Nc 55 International Finestra / Nc 68 Superthermic Finestra  
**Morelli** Ma 8300  
**Ocma** Fc 47 Finestra / Fc 55 Finestra / Fc 60 Tt Finestra  
**Passerini** Ekip 40 Evoluzione 2 Ante / Ekip 40 Sormonto 2 Ante  
Ekip 50 Sormonto 2 Ante / Ekip Maastricht 53 Finestra  
Ekip Maastricht Th 60 Finestra / Ekip Maastricht Th 68 Finestra  
**Profilati** "Pe" "Eku 53" Finestra / "Pe" "Eku 64 Tt" Finestra  
"Pe" "Eku 72 Tt" Finestra"

Striking plates

**FOR CENTRAL LOCK PERFORMA.**

Stainless steel. Flat front plate **22x3x180.**

**038231** C 10 - 10



Full-size scale



**Alcan** Abithal Cristal / Abithal Keeper Porta C.E.  
Winner Finestra  
**Alcoa** Fb 12 Ga / Europa Ga / Fb 12 T.T. / R 35 Reversibile  
R 35 Sormonto  
**All.Co** Export 40 Finestra / Export 50 Finestra  
Export 50 Tt Finestra / Final 40 Finestra / Sicurblin C.E.  
**Alu-mec** Synthesis 45 Finestra / Synthesis 57 Finestra  
Synthesis 60 Tt Finestra  
**Alusuisse** Alsec 2000 Finestra 59 / Alsec 2000 Finestra 69  
**Bodega** Bga 50 / New Bt 60  
**Domal** Domal Break 52 Finestra / Domal Break 70 Finestra  
Domal Stopper Pg Finestra  
**Equipe** Sistema 8000 G.A. Finestra 1 Anta  
Sistema 8000 G.A. Finestra 2 Ante  
**Esa** Isola Porta  
**Esedra** Ga 53 Porta / Ga 53 Porta / Tt 63 Porta / Tt 63 Porta  
Tt 75 Porta / Tt 75 Porta  
**Indinvest** Gold 400 Complanare / Gold 400 Sormonto  
Gold 500 Complanare / Gold 500 Sormonto  
Gold 600 Complanare / Gold 600 Sormonto  
**Metra** Nc 45 International Finestra / Nc 45 Superthermic Finestra  
Nc 55 International Finestra / Nc 68 Superthermic Finestra  
**Morelli** Ma 8300  
**Ocma** Fc 47 Finestra / Fc 55 Finestra / Fc 60 Tt Finestra  
**Passerini** Ekip 40 Evoluzione 2 Ante / Ekip 40 Sormonto 2 Ante  
Ekip 50 Sormonto 2 Ante / Ekip Maastricht 53 Finestra  
Ekip Maastricht Th 60 Finestra / Ekip Maastricht Th 68 Finestra  
**Profilati** "Pe" "Eku 53" Finestra / "Pe" "Eku 64 Tt" Finestra  
"Pe" "Eku 72 Tt" Finestra"

Striking plates

**FOR CENTRAL LOCK PERFORMA.**

in stainless steel. Flat front plate **22x1,5x180.**

**038235** D 10 - 10

For locks for metal frames series 72\*



Code

Min. ord.  
Multiple package  
Single package  
Status

Perforza



Full-size scale

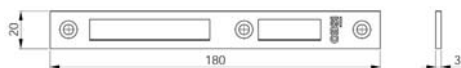

METRA PARETI MOBILI

Striking plates

**FOR CENTRAL LOCK** PERFORMA.

Stainless steel. Flat front plate **20x3x180**.

**038228** D 10 - 10



Full-size scale



**ALCOA** Fb 12 Blindato  
Fb 12 Trad./Revamping  
Gr 9  
Plana 1 Anta  
**ESA** Blindal 60 Porta 1 Anta  
Blindal 60 Porta 2 Ante  
**ESA** Blindal 70 Porta 1 Anta  
Blindal 70 Porta 2 Ante  
**SCHUCO** Royal S 50 N  
Royal S 55 Tt  
Royal S 65 Tt

Striking plates

**FOR DEVIATORS** PERFORMA.

Stainless steel. Flat front plate **24x3x132**.

**038220** C 10 - 10

Nickel plated. Flat front plate **24x3x132**.

**038220H3** D 10 - 10



Full-size scale

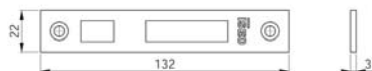

**Alcan** Abithal Cristal / Abithal Keeper Porta C.E.  
Winner Finestra  
**Alcoa** Fb 12 Ga / Europa Ga / Fb 12 T.T. / R 35 Reversibile  
R 35 Sormonto  
**ALL.Co** Export 40 Finestra / Export 50 Finestra  
Export 50 Tt Finestra / Final 40 Finestra / Scurbin C.E.  
**Alu-mec** Synthesis 45 Finestra / Synthesis 57 Finestra  
Synthesis 60 Tt Finestra  
**Alusuisse** Alsec 2000 Finestra 59 / Alsec 2000 Finestra 69  
**Batlega** Bga 50 / New Bt 60  
**Domal** Domal Break 52 Finestra / Domal Break 70 Finestra  
Domal Stopper Pg Finestra  
**Equip** Sistema 8000 G.A. Finestra 1 Anta  
Sistema 8000 G.A. Finestra 2 Ante  
**Esa** Isola Porta  
**Esadra** Ga 53 Porta / Ga 53 Porta / Tt 63 Porta / Tt 63 Porta  
Tt 75 Porta / Tt 75 Porta  
**Indinvest** Gold 400 Complanare / Gold 400 Sormonto  
Gold 500 Complanare / Gold 500 Sormonto  
Gold 600 Complanare / Gold 600 Sormonto  
**Metra** Nc 45 International Finestra / Nc 45 Superthermic Finestra  
Nc 55 International Finestra / Nc 68 Superthermic Finestra  
**Morelli** Ma 8300  
**Oma** Fc 47 Finestra / Fc 55 Finestra / Fc 60 Tt Finestra  
**Passerini** Ekip 40 Evoluzione 2 Ante / Ekip 40 Sormonto 2 Ante  
Ekip 50 Sormonto 2 Ante / Ekip Maastricht 53 Finestra  
Ekip Maastricht Th 60 Finestra / Ekip Maastricht Th 68 Finestra  
**Profilati** \*Pe \*\*Eku 53\*\* Finestra / \*Pe \*\*Eku 64 Tt\*\* Finestra  
\*Pe \*\*Eku 72 Tt\*\* Finestra

Striking plates

**FOR DEVIATORS** PERFORMA.

Stainless steel. Flat front plate **22x3x132**.

**038221** C 10 - 10

**For locks for metal frames  
series 72\***



Code

Min. ord.  
Multiple  
package  
Single  
package  
Status

**Perforza**

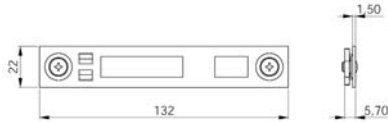

Full-size scale

- Alcan Abithal Cristal / Abithal Keeper Porta C.E.
- Winner Finestra
- Alcoa Fb 12 Ga / Europa Ga / Fb 12 T.T. / R 35 Reversibile R 35 Sormonto
- ALL.Co Export 40 Finestra / Export 50 Finestra
- Export 50 Tt Finestra / Final 40 Finestra / Sicurblin C.E.
- Alu-mec Synthesis 45 Finestra / Synthesis 57 Finestra
- Synthesis 60 Tt Finestra
- Alusuisse Alsec 2000 Finestra 59 / Alsec 2000 Finestra 69
- Bodega Bga 50 / New Bt 60
- Domal Domal Break 52 Finestra / Domal Break 70 Finestra
- Domal Stopper Pg Finestra
- Equipe Sistema 8000 G.A. Finestra 1 Anta
- Sistema 8000 G.A. Finestra 2 Anta
- Esa Isola Porta
- Esedra Ga 53 Porta / Ga 53 Porta / Tt 63 Porta / Tt 63 Porta
- Tt 75 Porta / Tt 75 Porta
- Indinvest Gold 400 Complanare / Gold 400 Sormonto
- Gold 500 Complanare / Gold 500 Sormonto
- Gold 600 Complanare / Gold 600 Sormonto
- Metra Nc 45 International Finestra / Nc 45 Superthermic Finestra
- Nc 55 International Finestra / Nc 68 Superthermic Finestra
- Morelli Ma 8300
- Ocma Fc 47 Finestra / Fc 55 Finestra / Fc 60 Tt Finestra
- Passerini Ekip 40 Evoluzione 2 Ante / Ekip 40 Sormonto 2 Ante
- Ekip 50 Sormonto 2 Ante / Ekip Maastricht 53 Finestra
- Ekip Maastricht Th 60 Finestra / Ekip Maastricht Th 68 Finestra
- Profiliati \*Pe \*\*Eku 53\*\* Finestra / \*Pe \*\*Eku 64 Tt\*\* Finestra
- \*Pe \*\*Eku 72 Tt\*\* Finestra

Striking plates

**FOR DEVIATORS PERFORMA.**

Stainless steel. Flat front plate **22x1,5x132.**

**038225** D 10 - 10

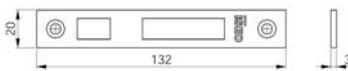

Full-size scale

METRA PARETI MOBILI

Striking plates

**FOR DEVIATORS PERFORMA.**

Stainless steel. Flat front plate **20x3x132.**

**038227** D 10 - 10