



2014_{bis}

OLIVARI 

Dal 1911 Olivari realizza maniglie in Italia,
all'interno dei propri stabilimenti,
dove si svolge l'intero ciclo produttivo.

Partendo da barre in ottone, le maniglie vengono
stampate, lavorate, smerigliate, lucidate,
cromate e marchiate al laser.

Olivari ha ottenuto le certificazioni
ISO 9001 e ISO 14001

e si avvale delle tecnologie più evolute,
ma ha mantenuto tutta la sapienza artigianale
accumulata in cento anni di storia.

Since 1911 Olivari has been manufacturing handles
at its own factories in Italy

where the entire production process takes place.

Starting with brass billets, the handles are forged, milled,
polished, buffed, chrome-plated and hallmarked with a laser.

Olivari has attained ISO 9001
and ISO 14001 certifications.

Though it uses the most advanced technology,
Olivari preserves all the artisanal wisdom
it has accumulated in 100 years of history.

OLIVARI 

Marcel Wanders

Ben van Berkel

due designer olandesi

due stili contrapposti

two duch designers

two opposite styles

Dolce Vita

design Marcel Wanders 2014

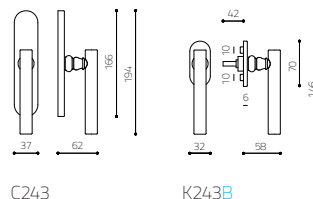
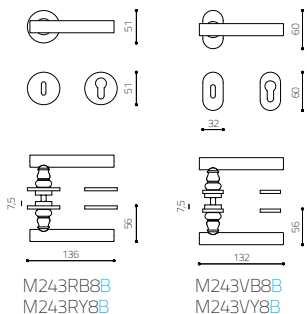

CR cromato/chrome



CO cromato opaco/mat chrome



US super antracite satinato
super anthracite satined



Il design poetico e visionario di Marcel Wanders unisce intuito, fascino e fantasia. Capace di riaccendere la passione per stili d'epoche passate ed il gusto per la stravaganza nel mondo dell'interior design e dei complementi d'arredo, Wanders ha interpretato il tema della maniglia con il suo stile originale e glamour. Dolce Vita, per le sue forme eleganti ed armoniose, invita ad essere accarezzata, accompagnando il gesto consueto dell'attraversare un passaggio all'emozione della sensazione tattile. Come un gioiello esalta l'incarnato di chi lo indossa, così il dettaglio della maniglia impreziosisce la superficie della porta, diventandone punto focale. Un elemento ispirato a stilemi più classici ed un volume geometrico perfettamente cilindrico generano un connubio inedito tra due linguaggi apparentemente in antitesi, una meravigliosa polarità che per la prima volta si fonde nel disegno di una maniglia.

The poetic and visionary design by Marcel Wanders combines intuition, charm and inspiration. Able to rekindle the passion for past ages and a taste for sensuality in the world of interior design and home environment, Wanders has interpreted the theme of the door handle with its original style and glamour. Dolce Vita, with its elegant and harmonious shape, beckons to be caressed, making the passageway from emotion to tactile sensation. Like a jewel enhances the complexion of the wearer, so the detail of the door handle embellishes the surface of the door, becoming the focus point. A classical inspired element and a perfectly cylindrical and minimal one generate a new relationship between two seemingly antithetical languages, resulting in a wonderful polarity that merges into the design of a door handle for the first time.





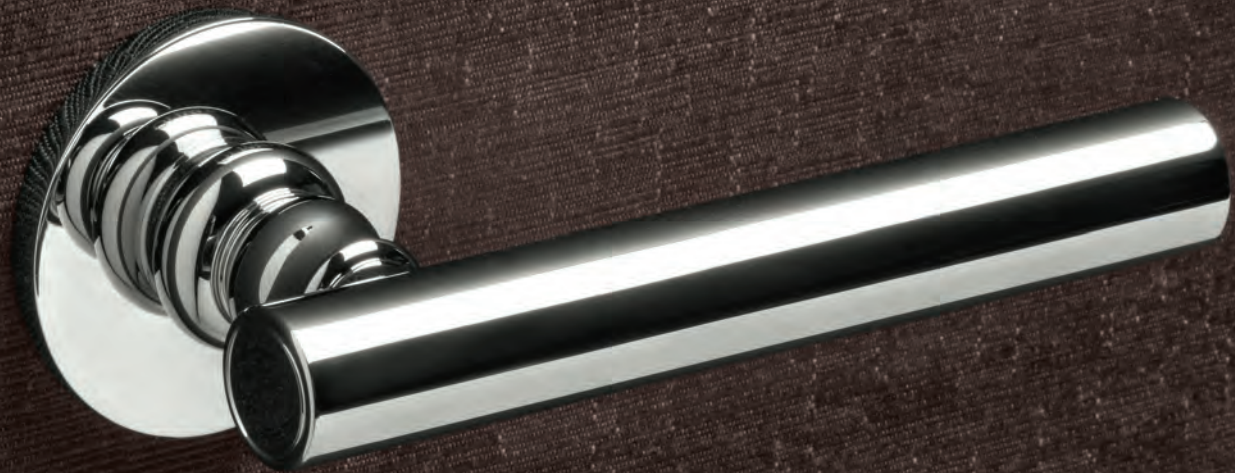

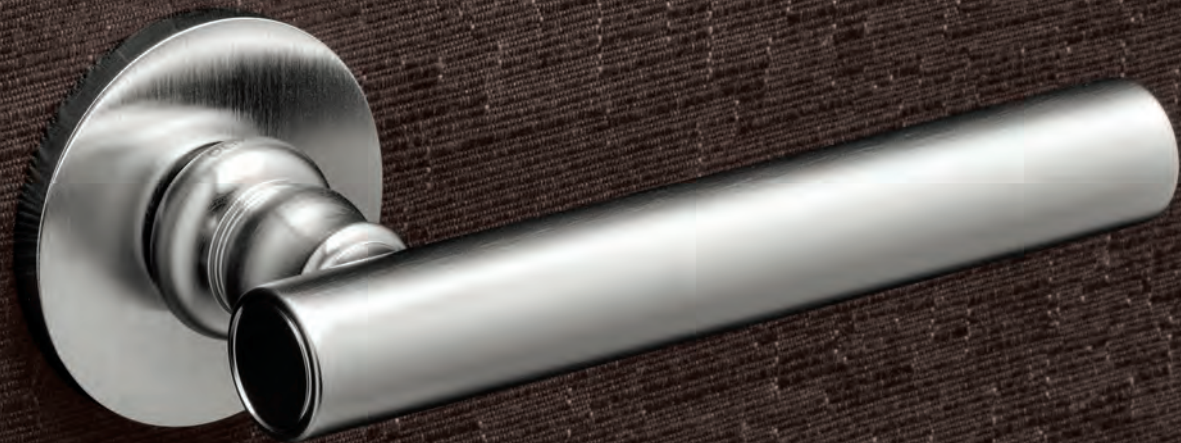



Flos, Zeppelin, 2005

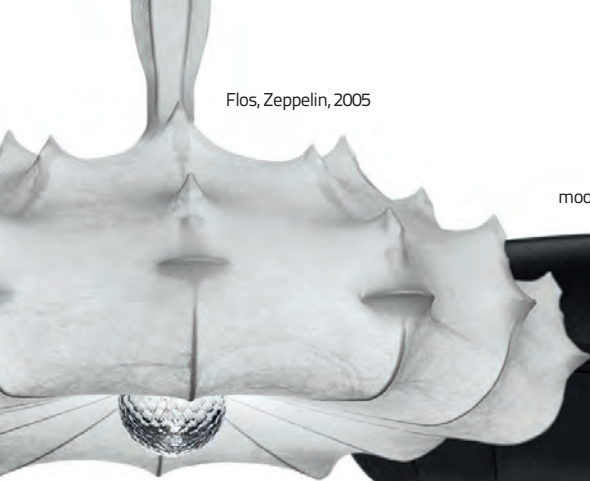

moooi_containerbowl



Moooi_lighting collection Double Round light



Moooi Parent Chair



love_chair moooi

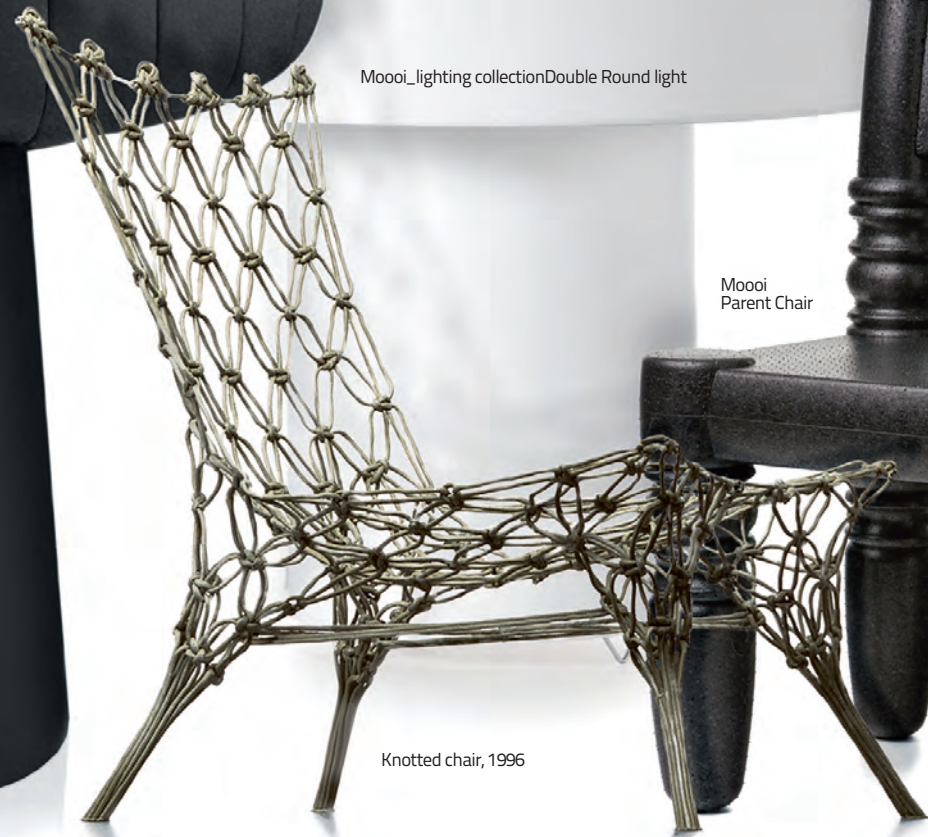

Knotted chair, 1996



Marcel Wanders

Boxtel, 1963

Considerato da molti come un'anomalia nel mondo del design, Marcel ha fatto del suo lavoro una missione, "creare un ambiente di amore, vivere con passione, e rendere i nostri sogni più emozionanti". I suoi lavori eccitano, provocano, e polarizzano, e non mancano mai a sorprendere per la loro ingenuità, audacia, come singolare tentativo di elevare lo spirito umano, e intrattenere. La principale preoccupazione di Marcel è quella di portare il tocco umano di nuovo al design, inaugurando quello che lui chiama di design 'new age,' in cui designer, artigiani e utilizzatori finali si ricongiungono. Nel suo processo, Marcel definisce il suo dogma di progettazione, preferendo, invece che concentrarsi su soluzioni olistiche, la tecnocrazia. Nell'universo di Marcel, la freddezza dell'industrialismo è sostituita invece dalla poesia, fantasia e romanticismo di età diverse, vividamente portato alla vita nel momento contemporaneo.

Regarded by many as an anomaly in the design world, Marcel has made his mission to "create an environment of love, live with passion and make our most exciting dreams come true." His work excites, provokes, and polarizes, but never fails to surprise for its ingenuity, daring and singular quest to uplift the human spirit, and entertain. Marcel's chief concern is bringing the human touch back to design, ushering in what he calls design's 'new age;' in which designer, craftsperson and user are reunited. In his process, Marcel defies design dogma, preferring instead to focus on holistic, technocratic solutions. In Marcel's universe, the coldness of industrialism is replaced instead by the poetry, fantasy and the romance of different ages, vividly brought to life in the contemporary moment.

Twist

design Ben van Berkel 2014

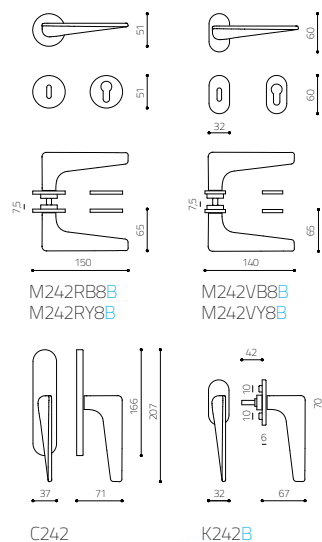

ottone/brass



CR cromato/chrome



CO cromato opaco/mat chrome



US super antracite satinato
super anthracite satined



IS superinox satinato
superstainlesssteel satined

La torsione architettonica è stato un elemento chiave nella progettazione di una serie di progetti UNStudio su scale diverse - da edifici a padiglioni - e ora è stato adattato nel disegno della maniglia per porta 'Twist'. In 'Twist' la curva architettonica viene ridotta nella proporzione e trasformata in un quadro tattile sulla scala umana, che è direttamente collegata al corpo e al tatto. 'Twist' è un oggetto semplice con una geometria complessa che unisce e consolida le caratteristiche duali. Nell'anatomia della leva, il cilindro che circonda il quadro si trasforma fluidamente nel piano piatto della leva, modificandosi senza soluzione di continuità da tubo a superficie. La sagoma ergonomica che viene creata da questo graduale trasformazione effettua un movimento dinamico congelato in materiale solido e presenta un equilibrio tra il moderno e il classico. Il volume che si curva e si rastrema sul lato inferiore della leva ospita comodamente la presa del pollice e dell'indice, mentre la superficie piana della leva reagisce alla pressione generata dal palmo della mano. La maniglia 'Twist' è inclinata con un angolo di 3 gradi verso la porta, per permettere una migliore e facile presa.

The architecture's torsion has been a key element in the design of a series of UNStudio projects on different scales - from buildings to pavilions - and has now been adapted in the design of the door handle 'Twist'. In 'Twist' the architectural curve is reduced in proportion and brought to a human scale, which is directly connected to the body and to touch. 'Twist' is a simple object with a complex geometry that combines and consolidates dual characteristics. In the anatomy of the lever, the cylinder that surrounds the spindle turns smoothly into the flat surface of the lever, seamlessly altering from tube to surface. The ergonomic shape that is created by this gradual transformation performs a dynamic movement frozen in solid material creating a balance between the modern and the classic. The volume that is curved and tapers on the lower side of the lever comfortably accommodates the grip of the thumbs, while the flat surface of the lever reacts to the pressure generated by the palm of the hand. The door handle 'Twist' is inclined with an angle of 3 degrees to the door, to allow for better and easy grip.













Grand Musée de l'Afrique, Algeria, 2013



Kutaisi International Airport, Georgia, 2011 - 2013

ph ©Nakanimamasakhisi



Ben Van Berkel

Utrecht, 1957

Nel 1998 Ben van Berkel e Caroline Bos fondano lo studio UNStudio (United Net). Si presenta come una rete di specialisti in architettura per lo sviluppo urbano delle infrastrutture. I progetti in corso sono la ristrutturazione dell'area della stazione di Arnhem, il mixed-use Raffles City a Hangzhou, un master plan per Basauri, un teatro di danza di San Pietroburgo e la progettazione e la ristrutturazione del porto di Ponte Parodi a Genova. Ben van Berkel ha tenuto conferenze e insegnato in molte scuole di architettura di tutto il mondo. Attualmente è professore di progettazione concettuale alla Staedelschule di Francoforte sul Meno. Punto centrale del suo insegnamento è l'approccio inclusivo di opere architettoniche che integrano organizzazione virtuale, materiali e opere di ingegneria.

In 1998 Ben van Berkel and Caroline Bos established UNStudio (United Net).

UNStudio presents itself as a network of specialists in architecture, urban development and infrastructure. Current projects are the restructuring of the station area of Arnhem, the mixed-use Raffles City in Hangzhou, a master plan for Basauri, a dance theatre for St. Petersburg and the design and restructuring of the Harbor Ponte Parodi in Genoa. Currently he is Professor Conceptual Design at the Staedelschule in Frankfurt am Main. Central to his teaching is the inclusive approach of architectural works integrating virtual and material organization and engineering constructions.

SUPERANTRACITE SATINATO

Dalla ricerca Olivari una nuova finitura

Olivari introduce nella propria gamma una nuova finitura, accogliendo le richieste degli architetti e degli arredatori di interni che sempre più cercano prodotti dal carattere forte, capaci di integrarsi con l'interior decor e l'architettura senza sovrastarli.

Nasce SuperAntracite Satinato, prima e unica finitura nel suo genere applicata alla maniglia.

Un grigio molto scuro, dai riflessi metallici, una durezza superficiale superiore e prestazioni tipiche delle finiture SuperFinish, garantita di 10 anni.

Una finitura dalle migliorate performance qualitative rispetto ai già alti standard dell'azienda, che dona nuova vita alle maniglie in un gioco di contrasti geometrici e di eleganza.

Ricordiamo che Olivari ha ricevuto la Menzione D'onore ADI 2014 proprio per il lavoro incessante nei Processi di Ricerca e Innovazione: SuperAntracite Satinato è l'ultimo dei traguardi raggiunti dall'azienda grazie all'applicazione e allo sviluppo di processi che sono tipici del mondo dell'aeronautica.

SUPERANTHRACITE SATINED

From Olivari's research a new finishing

Olivari introduces to its range a new finish, responding to the demands of architects and interior designers who increasingly look for products with a strong properties, that are able to be integrated with interior decor and architecture without dominating.

This has brought about SuperAnthracite Satined, the first and only finishing of its kind applied to a door handle. Very dark gray with a metallic sheen, a higher superficial hardness and the performance of a SuperFinish, with 10-year warranty.

A finish with improved quality and performances to match the already high standards of the company. Bringing new life to the handles in a game of contrasts and geometric elegance.

Olivari has received the Mention of Honor ADI 2014 for its ongoing work in Research and Innovation Processes: SuperAnthracite Satined is the latest achievement reached by the company through the application and development of processes which are typical of the world of aeronautics





Beta



Blindo



Conca



Diana



Euclide



Lama



Link



Living



Lotus Q



Lucy



Nina



Planet Q



Radial



Total



Trend

Il catalogo ed i prodotti sono soggetti ad aggiornamenti.

Modelli e marchi depositati.

Tutti i diritti riservati © Olivari B. s.p.a.

Catalog and products subject to updating.

Registered trademarks and patented designs.

All rights reserved © Olivari B. s.p.a.

Concept and graphic

Marco Strina

Photo

Coppi Barbieri (pag 5, 13)

Sauro Sorana

Press Office

Clara Buoncristiani

Pre press

Up studio_Milano

Printed in Italy

OGM_Padova 01.2014

thanks to

Marcel Wanders studio

UNstudio

Olivari B. spa

Via Giacomo Matteotti, 140
28021 Borgomanero NO Italy

T +39 0322 835080

F +39 0322 846484

olivari@olivari.it

www.olivari.it



olivari.it